

CAPITAL UNIVERSITY OF SCIENCE AND
TECHNOLOGY, ISLAMABAD



**Voice Behavior with its
Antecedents and Outcomes
through the Lens of Proactive
Behavior Theory**

by

Um-e-Rubbab

A thesis submitted in partial fulfillment for the
degree of Doctor of Philosophy

in the

Faculty of Management & Social Sciences

Department of Management Sciences

2021

Voice Behavior with its Antecedents and Outcomes through the Lens of Proactive Behavior Theory

By

Um-e-Rubbab

(DMS161002)

Dr. Bahaudin G Mujtaba, Professor

Nova, Southeastern University, Florida USA

(Foreign Evaluator 1)

Dr. Kate Davis, Associate Professor

Kingston Business School, Kingston University, London, UK

(Foreign Evaluator 2)

Dr. S. M. M. Raza Naqvi

(Thesis Supervisor)

Dr. Lakhi Muhammad

(Head, Department of Management Sciences)

Dr. Arshad Hassan

(Dean, Faculty of Management & Social Sciences)

DEPARTMENT OF MANAGEMENT SCIENCES
CAPITAL UNIVERSITY OF SCIENCE AND TECHNOLOGY
ISLAMABAD

2021

Copyright © 2021 by Um-e-Rubbab

All rights are reserved. No Part of the material protected by this copy right notice may be reproduced or utilized in any form or any means, electronic or mechanical, including photocopying, recording or by any information storage and retrieval system, without the permission from the author.

*Dedicated to My beloved father **Sardar Sikandar Hayat Khan** You raised me up, so I can stand on mountains You raised me up to walk on stormy seas You raised me up to more than I can be You raised me up by holding my hand in all cruel times and my dear mother **Chandni Begum** for always being there for me for listening to me, and for sharing all my triumphs, tears and fears.*



CAPITAL UNIVERSITY OF SCIENCE & TECHNOLOGY ISLAMABAD

Expressway, Kahuta Road, Zone-V, Islamabad
Phone: +92-51-111-555-666 Fax: +92-51-4486705
Email: info@cust.edu.pk Website: <https://www.cust.edu.pk>

CERTIFICATE OF APPROVAL

This is to certify that the research work presented in the thesis, entitled “**Phubbing in the Workplace; Exploring the Role of Rejection Sensitivity in the Relationship between Supervisor Phubbing and Employee**” was conducted under the supervision of **Dr. Samyia Safdar**. No part of this thesis has been submitted anywhere else for any other degree. This thesis is submitted to the **Department of Management Sciences, Capital University of Science and Technology** in partial fulfillment of the requirements for the degree of Doctor in Philosophy in the field of **Management Sciences**. The open defence of the thesis was conducted on **September 01, 2021**.

Student Name : Raja Mehtab Yasin (DMS153002) _____

The Examination Committee unanimously agrees to award PhD degree in the mentioned field.

Examination Committee :

- (a) External Examiner 1: Dr. Tasneem Fatima,
Associate Professor
IIU, Islamabad
- (b) External Examiner 2: Dr. Shazia Akhtar,
Professor
SZABIST, Islamabad Campus
- (c) Internal Examiner : Dr. S. M. M. Raza Naqvi
Associate Professor
CUST, Islamabad

Supervisor Name : Dr. Samyia Safdar
Assistant Professor
CUST, Islamabad

Name of HoD : Dr. Lakhi Muhammad
Assistant Professor
CUST, Islamabad

Name of Dean : Dr. Arshad Hassan
Professor
CUST, Islamabad

AUTHOR'S DECLARATION

I, **Um E Rubbab (Registration No. DMS-161002)**, hereby state that my PhD thesis titled, **“Voice Behavior with its Antecedents and Outcomes through the Lens of Proactive Behavior Theory”** is my own work and has not been submitted previously by me for taking any degree from Capital University of Science and Technology, Islamabad or anywhere else in the country/ world.

At any time, if my statement is found to be incorrect even after my graduation, the University has the right to withdraw my PhD Degree.



(Um E Rubbab)

Dated: November, 2021

Registration No : DMS161002

PLAGIARISM UNDERTAKING

I solemnly declare that research work presented in the thesis titled “**Voice Behavior with its Antecedents and Outcomes through the Lens of Proactive Behavior Theory**” is solely my research work with no significant contribution from any other person. Small contribution/ help wherever taken has been duly acknowledged and that complete thesis has been written by me.

I understand the zero tolerance policy of the HEC and Capital University of Science and Technology towards plagiarism. Therefore, I as an author of the above titled thesis declare that no portion of my thesis has been plagiarized and any material used as reference is properly referred/ cited.

I undertake that if I am found guilty of any formal plagiarism in the above titled thesis even after award of PhD Degree, the University reserves the right to withdraw/ revoke my PhD degree and that HEC and the University have the right to publish my name on the HEC/ University Website on which names of students are placed who submitted plagiarized thesis.



(Um E Rubbab)

Dated: November, 2021

Registration No : DMS161002

List of Publications

It is certified that the following publication has been made out of the research work that has been carried out for this thesis:

1. Um-e-Rubbab & Naqvi, S. M. M. R. (2020). Employee Voice Behavior as a Critical Factor for Organizational Sustainability in the Telecommunications Industry, *PLoSOne*, 15 (9), 1-17 e0238451.

Um-e-Rubbab

(DMS161002)

Acknowledgement

It's the grace of **ALMIGHTY ALLAH** that has led this work to its completion. The Gracious and All-Compassionate. I can never dare to deny HIS gifts that HE has granted me, the best of which is that HE has blessed me with the torch of eternal guidance in the form of HIS **Holy Prophet (PBUH)**, who is the knowledge for humanity as a whole. HE blessed me with the teachings of Hazrat Ali (A.S) who is the door to wisdom. I sincerely thank my supervisor, **Dr. S. M. M. Raza Naqvi**, Department of Management Sciences, Capital University of Science and Technology Pakistan, for his un-matchable and dedicated supervision for the completion of this study. He has been extremely patient, helpful, and cooperative. He not only guided me for thesis work but also helped me to see the world in better and practical ways.

A special thank goes to my mentors, **Dr. Sajid Bashir** for his constant support through my academic and research career. He supervised my thesis during my MBA. I thank **Dr. Khurram Shehzad** for being my supervisor in my MS thesis. I would also thank **Dr. Tasneem Fatima** for clearing clouds related to research while teaching Advanced Quantitative Techniques.

I would like to thank my friends, without whom I would not have been able to complete this research, and without whom I would not have made it through my doctoral degree! And without whom, this degree was never possible. A special thanks to **Dr. Muhammad Irshad Burki**. He has always been there even when I was unable to move. He helped me to see the life in the darkest days.

I acknowledge my dear friends **Bali Shah, Mehwish Majeed, Sadaf Ahsan, Sadia Arshad, Shaheen Khan, Nazma G** and my dear late father, for accepting me as I am besides knowing all my evils. You are the people who know my dark side too but always stand beside me.

Um-e-Rubbab

(DMS161002)

Abstract

This study examined the antecedents and outcomes of both dimensions of voice behavior that are promotive voice behavior and prohibitive voice behavior through the lens of proactive behavior theory. Considering the importance of voice behavior for organization, this study aims to study that how workplace should be designed to foster employees to engage in voice behavior. It also aims to study importance of voice behavior for improved organizational functioning and to discuss that engaging in the voice behavior is not criticism over managers themselves since they are responsible for creating the policies for organization rather it is about flaws and issues in those policies that can hamper the organizational functioning. Convenience sampling was used and data were collected in four time lags to avoid common method bias. More than seven hundred questionnaires were distributed out of which four hundred fifteen were used with no missing values and outliers. Data were collected from employees and their immediate supervisors in different telecommunication firms in Pakistan. Dyads were developed. Confirmatory factor analysis confirmed the distinctiveness of variables incorporated in the study. The results of path analysis confirmed that core self-evaluation and supervisory delegation promote employees' engagement in voice behavior. Felt obligation for constructive change and emotion regulation mediates the relationship between antecedents and voice behavior. This study contributes to the literature of employee voice behavior since limited attention was paid to examine the outcomes of both dimensions of voice behavior. Managerial hatred, workplace inclusion, and workplace exclusion were studied as outcomes of voice behavior. Study findings report that there is negative relationship between employee promotive voice and managerial hatred since that promotive voice is perceived constructive by managers. There is positive relationship between prohibitive voice and managerial hatred because prohibitive voice is considered as a criticism and complaint by managers. Findings also revealed that there is a positive relationship between promotive voice and employee perceived workplace inclusion by others as it is considered that the voice being raised is for collective betterment of all. Whereas negative relationship

between prohibitive voice and perceived workplace inclusion was not supported because prohibitive voice behavior is considered critical for improved organizational functioning. The negative relationship between promotive voice and perceived workplace exclusion was not supported but the positive relationship between prohibitive voice behavior and workplace exclusion is supported considering nature of voice as more a form of criticism and complaint. Role of voice climate was studied as the moderator for the relationship between felt obligation for constructive change and emotion regulation and outcomes i.e. both dimensions of voice behavior. Role of perceived risk was studied as the moderator for the relationship between both dimensions of voice behavior and possible outcomes that are managerial hatred, workplace inclusion and workplace exclusion. Pro-active behavior theory was used to support the findings. Implications for managers, policymakers, and researchers are also discussed in view of possible antecedents and outcomes of employee voice behavior. It is suggested that organizations need to focus on certain dispositional characteristics of employees and situational characteristics of workplace to provoke voice behavior among employees. The promotive voice is more future-oriented and attempts to make things better is considered constructive thus employees engaging in promotive voice behavior may face less unpleasant outcomes. Prohibitive voice behavior, which is more past and present-oriented, attempts to bring attention to factors that could turn loss to organizational sustainability and it is often interpreted as “what should be.” Thus it has more potential to challenge the status quo as most of the practices and policies are developed and shaped by senior management. Thus outcomes of prohibitive voice behavior may be less pleasant for voice raisers. Whereas an organizational climate that is high for expectation for voice behavior i.e., voice climate and involves lesser fears for engagement in voice behavior i.e. perceived risk is equally essential for assessing employees’ engagement in voice behavior.

Keywords: Voice Behavior; Supervisory Delegation; Core Self Evaluation; Felt Obligation for Constructive Change; Emotion Regulation; Voice Climate; Perceived Risk; Managerial Hatred; Workplace Inclusion; Workplace Exclusion.

Contents

Author’s Declaration	v
Plagiarism Undertaking	vi
List of Publications	vii
Acknowledgement	viii
Abstract	ix
List of Figures	xvii
List of Tables	xviii
Abbreviations	xix
1 Introduction	1
1.1 Background of the Study	1
1.2 Gap Analysis	9
1.2.1 Core Self Evaluation as a Predictor of Employee Voice Behavior	9
1.2.2 Impact of Supervisory Delegation on Employee Voice Behavior	11
1.2.3 Supervisory Delegation is Taken as an Antecedent to the Felt Obligation for Constructive Change	12
1.2.4 Felt Obligation for Constructive Change as a Psychological Antecedent to Explain both Voice Dimensions	14
1.2.5 Effectiveness of Both Dimensions of Voice Behavior	14
1.2.6 Hatred as an Outcome of Voice Behavior	16
1.2.7 Perception of Workplace Inclusion and Workplace Exclusion as Outcomes of Voice Behavior	18
1.2.8 Voice Climate as a Moderator	21
1.2.9 Emotion Regulation as a Mediator between Personality, Situation-Specific Antecedents, and Voice Behavior	23

1.2.10	Perceived Risk as a Moderator between Voice Behavior and its Outcomes	25
1.2.11	Validation of Perceived Risk	27
1.3	Problem Statement	28
1.4	Research Questions	29
1.5	Research Objectives	30
1.6	Significance of the Study	31
1.6.1	Theoretical Significance	31
1.6.2	Practical Significance	32
1.7	Supporting Theory	33
1.7.1	Overarching Theory	33
1.7.2	Theory of Proactive Motivation	34
1.7.3	Proactive Goal Generation	34
1.7.4	Proactive Goal Striving	35
2	Literature Review	40
2.1	Background of Variables	40
2.1.1	Supervisory Delegation	40
2.1.2	Core Self Evaluation	42
2.1.3	Voice Behavior	44
2.1.4	Felt Obligation for Constructive Change	46
2.1.5	Voice Climate	47
2.1.6	Managerial Hatred	48
2.1.7	Workplace Inclusion	49
2.1.8	Workplace Exclusion	50
2.1.9	Perceived Risk	51
2.1.10	Emotion Regulation	52
2.2	Hypotheses Development	53
2.2.1	Relationship between Core Self Evaluation and Voice Behavior	53
2.2.2	Relationship between Supervisory Delegation and Voice Behavior	55
2.2.3	Mediating Role of Felt Obligation for Constructive Change between Core Self Evaluation and Voice Behavior	57
2.2.4	Felt Obligation for Constructive Change as a Mediator between Supervisory Delegation and Voice Behavior	59
2.2.5	Mediating Role of Emotion Regulation between Core Self Evaluation and Voice Behavior	63
2.2.6	Mediating Role of Emotion Regulation between Supervisory Delegation and Voice Behavior	65
2.2.7	Relationship between Voice Behavior and Managerial Hatred	67
2.2.8	Relationship between Voice Behavior and Perception of Workplace Inclusion	69

2.2.9	Relationship between Voice Behavior and Perception of Exclusion	71
2.2.10	Voice Climate as Moderator between Felt Obligation for Constructive Change and Voice Behavior	73
2.2.11	Voice Climate as Moderator between Emotion Regulation and Voice Behavior	75
2.2.12	Perceived Risk as a Moderator between Voice Behavior and its Outcomes	76
2.3	Hypothesized Model	80
2.3.1	Theoretical Framework	80
3	Research Methodology	81
3.1	Research Design	81
3.1.1	Type of the Study	81
3.1.2	Study Setting	82
3.1.3	Unit of Analysis	82
3.1.4	Time Horizon	82
3.1.5	Data Collection Procedure	83
3.2	Population	83
3.3	Sampling	84
3.4	Measurements	85
3.4.1	Core Self-Evaluations	85
3.4.2	Supervisory Delegation	85
3.4.3	Felt Obligation for Constructive Change	86
3.4.4	Emotion Regulation	86
3.4.5	Voice Behavior	86
3.4.6	Managerial Hatred	86
3.4.7	Perceived Workplace Inclusion	87
3.4.8	Perceived Workplace Exclusion	87
3.4.9	Perceived Voice Climate	87
3.4.10	Perceived Risk	87
3.5	Data Collection and Management	88
3.5.1	Time Lag 1- T1	89
3.5.2	Time Lag 2-T2	89
3.5.3	Time Lag 3-T3	89
3.5.4	Time Lag 4-T4	89
3.6	Pilot Study	89
3.6.1	Pilot Testing Reliabilities	90
3.6.2	Validity of the Instrument	90
3.7	Main Study	91
3.8	Sample Characteristics	91
3.8.1	Gender of Respondents	91
3.8.2	Marital Status	92
3.8.3	Age	92

3.8.4	Education	93
3.8.5	Experience	93
3.9	Measurement Model	93
3.10	Covariates	95
3.11	Reliability Analysis	97
4	Results and Findings	98
4.1	Descriptive Analysis	98
4.2	Correlation Analysis	101
4.3	Test of Hypotheses	101
4.3.1	Direct Paths	101
4.3.1.1	Test of Direct Hypothesis	101
4.3.2	Mediation Hypothesis	105
4.3.3	Moderation Hypothesis	107
4.4	Structural Equation Modeling Results	118
4.5	Summary of Hypotheses Status	120
5	Discussion, Implications, Future Directions and Conclusion	124
5.1	Discussion	124
5.1.1	Research Question 1: What is the Impact of Core Self-Evaluation and Supervisory Delegation as Individual and Situational Factor in Generating Employee Proactive Behavior i.e. Voice Behavior?	125
5.1.1.1	Hypothesis 1 and 2 Core-Self Evaluation and Voice Behavior	125
5.1.1.2	Hypothesis 3 and Hypothesis 4 Supervisory Delegation and Voice Behavior	127
5.1.2	Research Question 2: What is the Role of Cognitive Motivational State and Affect related Process i.e Felt Obligation for Constructive Change and Emotion Regulation Respectively as Possible Mediators between Individual Factor i.e. Core Self-Evaluation, Situational Factor i.e. and Supervisory Delegation and their Outcomes i.e. both Dimensions of Voice Behavior?	128
5.1.2.1	Hypothesis 6 and 7 Mediation of Felt Obligation for Constructive Change between Core Self-Evaluation and Voice Behavior	129
5.1.2.2	Hypothesis 8 Supervisory Delegation and Felt Obligation for Constructive Change	129
5.1.2.3	Hypothesis 9 and 10 Felt Obligation for Constructive Change and Voice Behavior	130
5.1.2.4	Hypothesis 11 and 12 Mediation of Felt Obligation for Constructive Change between Supervisory Delegation and Voice Behavior	131

5.1.2.5	Hypothesis 13 Core Self Evaluation and Emotion Regulation	132
5.1.2.6	Hypothesis 14 and 15 Emotion Regulation and Employee Voice Behavior	132
5.1.2.7	Hypothesis 16 and 17 Mediation of Emotion Regulation between Core Self Evaluation Employee Voice Behavior	133
5.1.2.8	Hypothesis 18. Supervisory Delegation and Emotion Regulation	133
5.1.2.9	Hypothesis 19 and 20. Mediation of Emotion Regulation between Supervisory Delegation and Voice Behavior	134
5.1.3	Research Question 3: What is the Impact of Employees' Proactive Behavior i.e. Voice Behavior in Generating the Perception of Managerial Hatred, Perceived Inclusion, and Perceived Exclusion?	135
5.1.3.1	Hypothesis 21 and 22 Voice Behavior and Managerial Hatred	135
5.1.3.2	Hypothesis 23 and Hypothesis 24 Voice Behavior and Perceived Workplace Inclusion	137
5.1.3.3	Hypothesis 25 and Hypothesis 26 Voice Behavior and Perceived Workplace Exclusion	139
5.1.4	Research Question 4: What is the Role of Work Context i.e. Voice Climate as a Moderator for the Relationship between Cognitive Motivational State and Affect related Process i.e. Felt Obligation for Constructive Change, Emotion Regulation and Proactive Behavior i.e. both Dimensions of Voice Behavior?	140
5.1.4.1	Hypothesis 27 and Hypothesis 28 Voice Climate as Moderator between Felt Obligation for Constructive Change and Voice Behavior	141
5.1.4.2	Hypothesis 29 and Hypothesis 30 Voice Climate as Moderator between Emotion Regulation and Voice Behavior	142
5.1.5	Research Question 5: Whether Perceived Risk Moderate the Relationship between Proactive Behaviors i.e. Voice Behavior and its Outcomes	142
5.1.5.1	Hypothesis 31 and Hypothesis 32 Perceived Risk as the Moderator between Voice Behavior and Managerial Hatred	143

5.1.5.2	Hypothesis 33 and Hypothesis 34 Perceived Risk as the Moderator between Voice Behavior and Perceived Workplace Inclusion	144
5.1.5.3	Hypothesis 35 and Hypothesis 36 Role of Perceived Risk as the Moderator between Voice Behavior and Perceived Workplace Exclusion	144
5.2	Theoretical Implications	146
5.3	Managerial Implications	147
5.4	Strengths of the Study	150
5.5	Limitations	151
5.6	Future Directions	152
5.7	Conclusion	153
	Bibliography	155
	Appendix-A	187

List of Figures

2.1	Research Model	80
4.1	Moderation of Voice Climate between FOCC and Promotive Voice .	110
4.2	Moderation of Voice Climate between Emotion Regulation and Promotive Voice	112
4.3	Moderation of Voice Climate between Emotion Regulation and Prohibitive Voice	113
4.4	Moderation of Perceived Risk between Promotive Voice and Managerial Hatred	114
4.5	Moderation of Perceived Risk between Prohibitive Voice and Managerial Hatred	115
4.6	Moderation of Perceived Risk between Promotive Voice and Workplace Inclusion	116
4.7	Moderation of Perceived Risk between Promotive Voice and Workplace Exclusion	117
4.8	Moderation of Perceived Risk between Prohibitive Voice and Workplace Exclusion	118

List of Tables

3.1	Alpha Reliabilities of Scales	90
3.2	Gender	92
3.3	Marital Status	92
3.4	Age	92
3.5	Education	93
3.6	Experience	93
3.7	Measurement Model	94
3.8	Average Variance Extracted and Maximum Shared Variance	95
3.9	Reliability of Variables	97
4.1	Descriptive Statistics	99
4.2	Correlation Analyses	100
4.3	Direct Paths	103
4.4	Results on the Mediating Roles of Felt Obligation for Constructive Change and Emotion Regulation	108
4.5	Moderation of Voice Climate between Felt Obligation for Constructive Change and Promotive Voice	110
4.6	Moderation of Voice Climate between Felt Obligation for Constructive Change and Prohibitive Voice	111
4.7	Moderation of Voice Climate between Emotion Regulation and Promotive Voice	111
4.8	Moderation of Voice Climate between Emotion Regulation and Prohibitive Voice	112
4.9	Moderation of Perceived Risk between Promotive Voice and Managerial Hatred	113
4.10	Moderation of Perceived Risk between Prohibitive Voice and Managerial Hatred	114
4.11	Moderation of Perceived Risk between Promotive Voice and Perceived Workplace Inclusion	115
4.12	Moderation of Perceived Risk between Prohibitive Voice and Perceived Workplace Inclusion	116
4.13	Moderation of Perceived Risk between Promotive Voice and Perceived Workplace Exclusion	117
4.14	Moderation of Perceived Risk between Prohibitive Voice and Perceived Workplace Exclusion	118
4.15	Structural Equation Modeling Results	119

Abbreviations

CSE	Core Self Evaluation
ER	Emotion Regulation
FOCC	Felt Obligation for Constructive Change
PR	Perceived Risk
PWIN	Perceived Workplace Inclusion
PWEX	Perceived Workplace Exclusion
SD	Supervisory Delegation
VC	Voice Climate

Chapter 1

Introduction

This specific chapter includes the description regarding the background of the study, gaps in the literature, problem statement, study significance, research questions and objectives. Lastly to understand the predictors and outcomes of employee voice behavior, an overarching Proactive Behavior Theory has been described.

1.1 Background of the Study

Change is inevitable in-universe, and organizations cannot be kept aloof from an ever-changing environment. Work environments are changing to respond to expeditious innovation, commercialization, and competition. Enhanced and globalized work environments have fostered organizations and its members to transform, acquire, and update continuously for long term survival and improved organizational performance (Berg, Grimstad, Skerlawaj & Cerne, 2017; Guo, Zhu & Zhang, 2020; Xue, Li & Li, 2020). Growing complications of workplace settings require employees to effectuate beyond what is expected of them and to perform extra-role behaviors (Bohlmann, Rudolph & Zacher, 2021; Kim, Shin & Gang, 2017). Once silence was considered golden and so was the silence of employees. Nowadays, organizations want to keep pace ahead of their competitors. Winning the race of competition is impossible with workers who just obey and do not participate through their feedback. Now is the trend that such employees are considered more

valuable for the organization who perform more than what is obligated by them. The dynamic, indefinite, and uncertain work environment has fostered the significance of proactive behaviors for the organization's long term survival and effectiveness (Parker & Collins, 2010; Aryee, Walumbwa, Mondejar & Chu, 2013). An instance of such proactive behaviors is the voice behavior of employees. Voice behaviors is discretionary in nature and known as proactive behaviors (Frese & Fay, 2001; Li, Frese & Haider, 2017). Proactive behaviors are extra role, future-oriented behaviors, and focuses on making things happen (Frese & Fay, 2001). Some of the concepts related to proactivity are taking charge behavior (Morrison, 1994), personal initiative behavior (Frese & Fay, 2001) as well as voice behavior (Van Dyne & Lepine, 1998).

This study is an attempt to explore the needs of ever-changing organizations and their environments which have increased the demand for employees which proves to be better soldiers for their work through their voice behavior, i.e. particular type of proactive behavior. The proactive behavior of employees is thought of critically significant for the enhanced functioning of the organization in an uncertain business environment (Aryee, Walumbwa, Mondejar, & Chu, 2017). Voice behavior is proactive in nature (Jiang, Li & Gollan, 2017), it promotes the improved workplace functioning (Liang, Farh & Farh, 2012) and tends to confront the existing status quo (Aryee et al., 2017). Voice behavior is of ultimate prominence for an organization's innovation (Zhou, Feng & Liu, 2017). Organizations, where employees prefer to remain silent and do not share their feedback may turn as harmful and indicates low engagement and motivation of employees (Agnihotri, 2017).

The voice behavior of employees has a significant role in improved organizational functioning (Satterstrom, Kerrissey, DiBenigno, 2021). Organizations have started to pay more attention to employee voice behavior due to its constructive nature (Song, Peng & Yu, 2020). Employee voice behavior has become the main array of interest of many of the researchers of diverse fields including industrial relation, human resource management and organizational behavior (Yang, 2021). There are various forms of proactive behaviors such as taking charge behavior (Morrison

& Phelps, 1999), individual innovation (Scott & Bruce, 1994), problem prevention (Frese & Fay, 2001), strategic scanning (Parker & Collins, 2010), issue selling (Dutton & Ashford, 1993), feedback (Ashford & Black, 1996), career initiative (Seibert, Kraimer, & Crant, 2001), and employee voice behavior (Van Dyne & LePine, 1998). Voice behavior is of utmost importance for the organizations because it helps in facilitating change process within organization and aids continuous improvement especially in challenging time (Van Dyne and LePine 1998; LePine and Van Dyne 1998). Voice behavior is a form of employee contextual performance which contributes to organizational success by aiming at social and psychological elements in workplace (Motowidlo et al. 1997).

Voice behavior is defined as a form of change oriented communication which intends to improve and recommend suggestions to the status quo even when faced with lots of disagreement from others at workplace (LePine and Van Dyne 2001; Kim et al. 2009; Van Dyne et al. 2003). Existing research suggested that more work needs to be conducted for identification of antecedents and outcomes of voice behavior (Parker et al, 2010; Avery & Quinones 2002). Voice behavior is more important than other behaviors because improvement oriented ideas cannot be solely expected from organization's top management especially in a current competitive and uncertain environment (Detert and Burris 2007). Employee voice behavior and voice opportunity to be heard and noticed by others is also related to justice perception perspective, especially procedural justice (Avery and Quinones 2002). Voice behavior from employees is crucial because senior management at times becomes myopic about their created policies and strategies so it becomes essential to have certain factors in organization which can highlight the issues and flaws in those management created policies. There are various outcomes of voice behavior which are very crucial for improved organizational functioning (Parker & Collins, 2010).

Voice behavior is a tool through which employees facilitate their organizations to remain innovative and adapt to the uncertain environment (Liang, Farh & Farh, 2012). It is about four decades ago when Hirschman (1970) firstly noted the significance of the voice behavior of employees to bring change rather than suffering from

an ineffective status quo. This behavior of employees was called as an employee voice and further claimed that it helps the organizations to survive in a changing environment. Voice behavior is about suggesting modifications to existing work practices even when others at the workplace do not agree with suggestions (Van Dyne & Lepine, 1998).

The literature on voice behavior indicates that research in the area of voice received lesser attention in the management field. An increase in research on voice area started after 1994 as Van Dyne, and LePine (1998) defined the voice behavior as well as developed a scale to measure it. They defined voice as an expression of the challenge with intentions to improve ways of doing things at the workplace. Furthermore, they proposed that employee voice has a constructive impact on the better functioning of an organization as it recognizes better ways of performing tasks, and guides management attention to solve the critical issues.

Voice behavior as a way to express constructive ideas and suggestions regarding work related issues is reflected as an effective way through which employees demonstrate their concern about their workplace (Liang, Frah & Farh, 2012). Voice behavior is aimed at improving organizational working methods, helps to prevent workplace from problems that may hinder organizational effectiveness and helps in taking benefits from opportunities (Madrid, 2020). Promotive and prohibitive are two dimensions of voice behavior and their distinction is explained by Liang and colleagues (2012). The promotive voice tells about suggestions for improvement of the processes of the organization. In opposition, the prohibitive voice states the anxieties linked to work behaviors, and procedures and practices that can possibly be troublesome (Liang et al., 2012).

Prohibitive voice is also essential as it focuses the surveillance towards such issues that are undetected yet. Employee's motivation for engagement in this sort of voice is basically to pull the workplace from scared conditions. While discussing both promotive and prohibitive dimensions of voice, most of the prevailing literature is about promotive aspects of voice, and a lesser amount of scholarly literature is available about the prohibitive aspect of voice. Promotive voice is related to better functioning of existing work practices, behaviors, and policies which might help the workplace to adjust to the uncertain environment (Van Dyne, Ang &

Botero, 2003; Van Dyne & LePine, 1998) whereas the prohibitive voice is related to existing work practices that are possibly harmful for the organization (Liang, Farh & Farh, 2012).

Existing research on voice behavior shows that an employee may engage in voice behavior to status up his position in the organization (Weiss & Morrison, 2018). Voice behavior of employee may result in positive evaluation and impression management (Burriss, 2012), increased unit level learning as well as better performance (MacKenzie, Podsakoff, & Podsakoff, 2011; Farh & Chen, 2014). Whereas as far as antecedents of voice behavior are concerned, the literature reveals that voice climate and personality characteristics of the employee may influence him to involve in voice behavior. (Morrison, Wheeler-Smith, & Kamdar, 2011; LePine & Van Dyne, 2001). Employees with high strive for achievement exhibit more voice behavior (Maynes & Podsakoff, 2014). Similarly, perceived support from others (Liang & Gong, 2013) and organizational identification is said to have its role in employee's motivation for voice behavior (Tangirala & Ramunjam, 2008). Psychological detachment, fear and abusive supervision are said to play an inhibiting role for employee's engagement in voice behavior (Weiss & Morrison, 2018; Farh & Chen, 2014).

Existing research on voice behavior has examined various dispositional and situational factors as predictors to voice behavior. According to a meta-analysis by Morrison (2014), conscientiousness, extraversion, and proactive personality may have their role in the prediction of voice behavior. Whereas negative affect and neuroticism are less likely to be associated with voice behavior (Chamberline, Newton & Lepine, 2017). The objective of this study is to build a framework based upon previous findings looking into the predictors which are not directly studied. Research shows that individuals who consider themselves as contributing to the organization, find themselves as more enthusiastic, courteous, have characteristics of agreeableness, personal initiative, and positive affect (e.g. Liang & Gong, 2013; Liu et al., 2014; Crant, Kim & Wang.,2011; Chamberline, Newton & Lepine, 2017) are more involved in voice behavior. Specifically based upon dispositional and situational antecedents of proactive behavior according to proactive behavior theory (Parker, Bindl & Strauss, 2010), core self-evaluations are taken

as a dispositional antecedent of pro-active behavior, i.e. voice behavior in this study. This study is an attempt to predict that whether there is any relationship between an employees' high core self-evaluation and his voice behavior. Previous studies shows that one's positive self-concept is an essential predictor for taking the initiative (Baumeister, Campbell, Krueger & Vohs, 2003). Core self-evaluation consists of higher-order traits which are self-esteem, self-efficacy, locus of control, and emotional stability (Aryee, et al., 2013). Judge et al. (2005) posited that these are specific characteristics that actually a person holds about himself or a general self-assessment.

Whereas considering the role of situational predictors of proactive behavior (Parker et al., 2010), supervisory delegation is taken as the predictor of employee voice behavior. Supervisory delegation is management's propensity at the senior level to assign responsibility, transfer of authority and empowerment of lower level employees (Yukl & Fu, 1999). The delegation has the potential to improve the decision-making skills of subordinates (Yukl & Fu, 1999); they feel trusted and valuable by the organization (Chen & Aryee, 2007). Parker Bindle and Strauss (2010) stated that situational characteristics play their role in the prediction of proactive behavior. Some of the situational factors include job design, supervisors' role, as well as workplace climate. Existing research on situational characteristics has found the role of job autonomy and control over job as potential predictors of voice behavior (Tangiralla & Ramunjam, 2008).

Followers' engagement in proactive behavior i.e. the voice behavior has also been predicted by participative and transformational leadership styles (Parker et al., 2010). The role of organizational climate also facilitates employees in shaping certain behaviors. If one perceives others receptive to them, has a quality relationship with others at the workplace, it would increase his tendency to engage in proactive behavior (Vandyne & Lepine, 1998; Ashford et al., 2002). When employees can endorse their actions and have autonomy to do their tasks, it enhances their motivation for engaging in voice behavior (Lam & Mayer, 2014; Liu et al., 2015). Thus it can be attributed that delegation by a supervisor may encourage employees' possibility for engaging in voice behavior. So this research is an extension to

previous studies on situational predictors to voice behavior by considering the role of supervisory delegation for employees' engagement in voice behavior.

Parker et al. (2010) in their proactive behavior theory, postulated that proactive behavior is ignited by certain motivational states consisting of cognitive motivational states and affect the related process. These states have can do, the reason to so and energized to do characteristics. Thus felt obligation for constructive change and emotion regulations are taken as precedents as well as mediators for proposed outcomes, i.e. voice behavior. The cognitive motivational state is considered as cold and affect the related process as hot motivational states (Mitchel & Daniel, 2003). Felt obligation for constructive change is a person's cognition that he is a responsible soldier of the organization and considers himself as obligated to act constructively for the organization (Liang, Farh & Farh, 2012; Fuller et al., 2006). It is a colder motivational state which is triggered with the help of emotion regulation in this study where emotion regulation is taken as a hot motivational state. Emotion regulation is an ability to respond with a range of emotions to ongoing demands. These reactions may be spontaneous as well as depending upon need. The process of voice behavior engagement is motivated by one's felt obligation for constructive change and emotion regulation (Chamberlin et al., 2017; Zimmerman, 2001), respectively.

Previous research on proactive behavior (e.g. Parker et al., 2010) posited that that pro-activity is a relevant and judicious topic for today's workplaces. It was suggested in proactive behavior theory that outcomes of proactive behavior are not always favorable for employees and suggested to look at adverse outcomes of pro-activity (Parker et al., 2010). This study is an attempt to extend their concluding remarks by taking negative as well as positive outcomes of voice behavior i.e. a type of proactive behavior. Adverse consequences of voice behavior are taken in the form of managerial hatred, and perceived exclusion and the positive outcome is taken in the form of perceived inclusion. Existing studies has predominantly explored the positive outcome of voice behavior in terms of improved decision making (Morrison & Milliken, 2000), crisis prevention (Schwartz & Wald, 2003), organizational learning (Argyris & Schon, 1978). This research would be

an addition on voice behavior literature by taking managerial hatred as well as the perception of exclusion and inclusion. Hatred is defined as extreme emotional dislike invoking feelings of anger, disgust, and resentment (Brudholm, 2010).

It can be against any individual, group, behavior, and even against ideas. Previous research has shown that one may develop negative emotions to voice behavior (Chiabaru et al., 2013). Inclusion is defined as a basic human need stemming from belongingness Maslow's (1987) hierarchy theory and everyone at the workplace needs to be included, recognized, and accepted by others (Shore et al., 2011). Whereas exclusion is a relatively broad term which is defined as the feeling of being left alone and lack of social contact by others at the workplace (Blackhart et al., 2009). Outcomes of voice behavior in the form of hatred, inclusion, and exclusion are also consistent with findings of the social identity theory of Tajfel and Turner (1979) according to which we develop in-groups and out-groups at the workplace. So when someone exhibits voice behavior, he/she is attributed based on the content of voice, if it is consistent with relevant others, the person is included and vice versa.

According to the proactive behavior theory of Parker et al., (2010), a person changes his/her behavior subject to the consequences. Thus if the outcome is resulting in the form of exclusion from others and hatred from the manager, it may decrease a person's propensity of engaging in voice behavior. Consequently, organizations can not prevent themselves from loss and harm and would remain unable to improve their functioning because of the negative outcomes of voice behavior. Antecedents and outcomes of this study are aligned to the remarks of Parker, Bindl, and Strauss (2010) that pro-activity can be shaped through a leader's behavior, work characteristics, and work climate. Thus core self-evaluation and supervisory delegation are taken as individual and situational antecedents of voice behavior. At the same time, negative as well as positive outcomes are incorporated to respond to the recent researchers as well as Parker et al. (2010) proactive behavior theory.

Lebel (2017) postulated that a large number of studies have explored individual-level factors to explore proactive behaviors and have overlooked collective level

factors to a more considerable extent to study pro-activity. Future researchers should explore group and collective level factors to study pro-activity. Voice climate is a factor that is maintained at the group and collective level. At the same time, Parker et al. (2010) in pro-active behavior theory is of the view that the contextual variable has the potential to moderate the relationship between the motivational state and proactive behavior theory. Voice climate is the shared perception of a workgroup for the decision to engage in voice behavior (Vandyne & Lepine, 1998).

1.2 Gap Analysis

1.2.1 Core Self Evaluation as a Predictor of Employee Voice Behavior

Studies on the importance of personality to influence job performance has increased in the past few years (Eto & Watanbe, 2014). Previous studies on personality have shown the big five-factor model as playing a role over employees' job performance (Lepine & Vandyne, 2001). Researchers recently are of the view that core self-evaluation is an emerging factor that may play its role in job performance (Eto & Watanbe, 2014; Judge, Erez, Bono, & Thoresen, 2003). Judge et al. (2003) stated that core self-evaluation consists of self-efficacy, self-esteem, locus of control, as well as neuroticism. Core self-evaluation, according to Aryee, Walumbwa, Mondejar & Chu, (2013), is a construct consisting of higher-order traits which are self-esteem, self-efficacy, locus of control, and emotional stability.

Judge et al. (2005) posited that these are specific characteristics that actually a person holds about himself or a general self-assessment. Eto & Watanbe, (2014), in their study, pointed out that core self-evaluation has not been equally considered with different performances as compared to other personality traits like conscientiousness. There is a lot of research on investigating the relationship between core self-evaluation and employees in-role performance (Kacmar, Collins, Harris & Judge, 2009; Joo, Jeung & Yoon, 2010; Judge, Erez, Bono & Thoreson,

2003). However, there is a lack of studies on the role of core self-evaluation as predictor of extra-role performance (Eto & Watanbe, 2014). This study is one of the attempts to study the relationship that exists between core self-evaluation and voice behavior. Extra-role performance consists of two dimensions which are helping and voice behavior (Vandyne & Lepine, 1998).

Core self-evaluation is said to have the potential to challenge the authority because such individuals are more self-confident and less worried in uncertain situations (Judge & Kammeyer-Mueller, 2011). This study is an attempt to study core self-evaluation as a precursor to voice behavior of employees as voice behavior is inclined to confront the status quo (Burris, 2012). Core self-evaluation is also linked with proactive coping (Judge & Kammeyer-Mueller, 2011). So it can be attributed that core self-evaluation may also have its role to impact extra-role performance because that proactive behavior is also extra-role behavior (Parker et al., 2010). Eto and Watanbe (2014) explored the relationship between core self-evaluation and extra-role performance. Considering these relationships which are already explored, and according to the new avenues for core self-evaluation link with other variables, this study is an attempt to study the relationship between core self-evaluation and voice behavior.

This study explores the notion that why employees differ in their tendency to engaging in voice behavior, i.e. proactive behavior. Recently, Wu, Parker, Wu & Lee (2018) stated that individuals' engagement in pro-activity is linked to self-construal that is employee engagement in pro-activity can be realized by their personal conception of individuality regarding goal processing. A high level of career commitment of employees fosters them to engage in higher-level or pro-activity behaviors which are career-specific (Parker et al., 2010).

Wu et al. (2018) claimed that self-construal is an essential predictor of proactive behavior and self-construal according to Markus and Kitayama (1991) is one notion about himself which helps in shaping life goals vital to oneself. Self-construal is a "reason to" engage in proactive behavior (Parker et al., 2010). It provides reason to people to engage or not engage in proactive behaviors to achieve or

avoid outcomes (Wu et al., 2018). Wu, Parker, Wu & Lee (2018) encouraged future researchers to explore the role of different motives in developing proactive behavior. Responding to their call, core self-evaluation is taken as a personality factor behind engagement in proactive behaviors where voice behavior is taken as proactive behavior. Core self-evaluation is said to be related to proactive problem solving (Judge & Kammeyer-Muller, 2011). Although in one of recent study by Pyclik (2020), core self-evaluation has been studied as predictor of voice behavior but gap exists to study both dimensions of voice behavior as outcomes of core self-evaluation. Voice behaviors is influenced by an individual's dispositional factors because it is discretionary in nature (Yang, 2021). So as suggested by Eto and Watanbe (2014) in their future directions that testing the relationship between core self-evaluation and authority challenging behaviors would be a new avenue for researchers. *Thus this study is an attempt to take core self-evaluation of employees as a predictor of voice behavior, i.e. proactive behavior according to recommendation suggested by the recent study of Wu et al. (2018).*

1.2.2 Impact of Supervisory Delegation on Employee Voice Behavior

Morrison and Milliken (2000) pointed out that organizations' practices and procedures are one the reason which restricts employees' engagement in voice behavior that further hinders their involvement in decision making. They are not provided with any mechanism to provide feedback. Delegation is the process of making employees empowered, authoritative and powerful and it refers to giving them more discretion in their decisions (Yukl, 1998). Delegation is a form of decentralization, e.g. which is defined as the transfer of power from senior authorities to lower levels. Decentralization has been documented many times but still its impact in the form of outcomes is inconclusive, vague, and inconsistent. This study has taken delegation a form of decentralization to study its impact on voice behavior. It is proposed that delegation by the manager may persuade subordinates to exhibit voice behavior. So managers may exert a broad level effect by creating a favorable and positive environment for promoting employee agency (Detert & Burris, 2007)

by delegating responsibilities to the next subsequent levels. Wei et al. (2015) suggested investigating this impact of leadership through supervisory delegation. Whereas, Davidson, Van Dyne, and Lin (2017) also indicated in their future directions that enhancing mechanism of voice needs to be explored in societies and organization which have ingrained hierarchical norms. They further added in the conclusion that different factors related to supervisor and subordinate relationship, including hierarchical, reciprocal, and affective should be explored to study their impact on voice behavior. Because in cultures that are expected to celebrate more autocracy and less delegation, it is quite apparent to understand substantial influence on employee's behavior. Nature and quality of relationships that the employees may have with their supervisor is a key precursor to employees' voice behavior and it influences employees perception for engaging in voice behavior (Yang, 2021). Yang (2021) stated that work related supportive behaviors of supervisors can be key antecedents to employee voice behavior. *Second gap of the study is regarding the effect of supervisory delegation on the voice behavior of employees.*

1.2.3 Supervisory Delegation is Taken as an Antecedent to the Felt Obligation for Constructive Change

Delegation is a form of decentralization in which management at senior levels delegates authority and responsibility to the next subsequent levels (Yukl & Fu, 1999). Numerous advantages of the supervisory delegation have been cited in literature by various researchers which are enhanced quality, quick decisions, employee commitment to the organization as well as it enriches the intrinsic motivation of workers (Yukl & Fu, 1999), better performance and job satisfaction of subordinates (Schriesheim, Neider & Scandura, 1998; Yukl & Fu, 1999), provides a deeper level of expertise and proficiency at employees level which may be lacking at senior level (Ito & Person, 1986) because subordinates are usually more close to problems and customers' concerns thus delegation increases the efficiency of the organization. The delegation also helps in decreasing the management burden over seniors and boosts the leadership skills of subordinates by making them self-sufficient in means

through which they can exercise their decision-making skills (Yukl & Fu, 1999). Delegation is quite significant to many issues such as organization management, employee autonomy, work involvement and flat hierarchies.

When employees are delegated, it may make them accountable towards their workplace and organizational functioning thus fostering a higher felt obligation for constructive change which forces them to improve the organizational processing and helps employees to point out the imperfections of the organization. Employees perceive themselves as more respected and trustworthy when they are delegated (Chen & Aryee, 2007). Similarly, despite various benefits of supervisory delegation, most of the work cited is of western context, with low power oriented cultures. An advantage of supervisory delegation in a strong power distance culture that have more vertical structure is still a debatable issue. Hofstede (1980), argued that managers in cultures high on power distance are less involved in delegation and vice versa. Felt obligation for constructive change is defined as a person's belief that he is obligated to pay back to the organization and considers himself as a responsible soldier of the organization (Liang et al., 2012). Existing research proposes that when employees consider themselves as valued by the organization, they try to improve their performance and it boosts their motivation for work behaviors (Weiss & Morrison, 2018; Janssen & Gao, 2015). Thus this research is going to explore this gap that how delegation by supervisors makes employees develop constructive obligations towards their workplace. Therefore it can be proposed that increased delegation boosts employee's sense that they can create some difference in organizational functioning; thus, delegation increases the propensity of employees engaging in the felt obligation for constructive change. So supervisory delegation is taken as an antecedent to the felt obligation for constructive change. Felt obligations means moral or social responsibility and duty to complete assigned task and not extending them to others (Mallory, Rupp, Pandey & Tay, 2020). Resource exchange (i.e delegation from supervisor) fosters employees to engage in reciprocated obligated behaviors towards organization i.e. felt obligation for constructive change (Babalola, Mawritz, Greenbaum, Ren & Garba, 2021). Receiving kind treatment from the workplace makes employees payback to the organization, and consequently, they are obligated to think for constructive change

for the organization. *Thus supervisory delegation is taken as an antecedent to the felt obligation for constructive change, and it is assumed that addressing this gap may add a body of knowledge to existing studies on voice behavior.*

1.2.4 Felt Obligation for Constructive Change as a Psychological Antecedent to Explain both Voice Dimensions

There is also a difference in the relationship for felt obligation for both types of voice, that is felt obligation has a stronger association with promotive voice than prohibitive voice (Chamberlin et al., 2017). Liang et al. (2012) stated that perceived obligation for constructive change might impact employee's inclination for engaging in voice behavior. Employees with felt obligation for constructive change are more likely to engage in proactive behaviors including taking charge behavior, and attempting to bring improved change at workplace (Mallory, Rupp, Pandey & Tay, 2020). In one of the recent study on antecedents of voice behavior, it has been stated that employee concern for the organization can be the source of employees' engagement in voice behavior (Yang, 2021). Song, Wu, Hao, Lu, Zhang & Liu (2017) recently studied psychological safety and psychological meaningfulness for the sake of brevity as antecedents for voice behavior and suggested future scholars to study other psychological antecedents to explain voice dimensions better. *Thus they left room for future researchers and suggested taking felt obligation for constructive change as a psychological antecedent to explain both voice dimensions separately.*

1.2.5 Effectiveness of Both Dimensions of Voice Behavior

Most of the previous research has taken voice as a single dimension. However, since the work of Liang, Farh, and Farh (2012) when it was added in the literature of voice the nature of both types of voices is different as promotive is used to improve work practices, and procedures whereas prohibitive is a way to express

concerns for harmful practices. The same was argued by Burris (2012). So because of this stated distinction, it is quite obvious to expect that manager would also respond differently to both types of voice. Promotive voice is perceived as more buoyant, so managers can likely identify the good intention of employees behind this. Consequently, a promotive voice has more chances to be endorsed by management. Prohibitive voice that is about indicating a decrease in workgroup productivity due to some unhealthy and wrong practices is perceived more challenging in nature. Status quo is challenged by the prohibitive voice of employees (Burris, 2012; Liang et al., 2012). Similarly, Maynes & Podsakoff (2014) also argued that to better recognize the reasons and outcomes of voice behavior, both dimensions which are promotive and prohibitive should be considered.

Though both dimensions i.e. promotive and prohibitive voice are constructive, not included in job description thus extra role behaviors and related to employees' contextual performance (Pyclik, 2020). Chamberlin, Newton, and Lepine (2017) argued that subordinates exhibiting promotive voice behavior are perceived as more efficient by their bosses than those subordinates who do not engage in promotive voice. Interestingly those engaging in prohibitive voice are interpreted as less efficient than those who do not engage in prohibitive voice. Chamberlin et al. (2017) proposed that the voice which reflects prospects for an organization's betterment is promotive in nature and awarded whereas, the voice that protects the workplace from harm and impairment is prohibitive in nature and disliked. Thus nature of voice is different, carrying different implications. Duan, Xu, Li, and Wu (2016) suggested for future researchers that differentiating in both types of voice is useful to better understand the voice behavior. Yang (2021) referred to the work of Liang and colleagues that most of the previous research has emphasized more the promotive work and paid less attention to the other dimension i.e. prohibitive work. More work is needed to study both dimensions of work i.e. promotive and prohibitive voice behavior as antecedents and outcomes of both dimensions largely differ (Bergeron & Thomson, 2020). *Chamberlin, Newton, and Lepine (2017) viewed that previous literature on the voice has taken both types as more in the undifferentiated form, which is incorrect and incomplete to develop and clarify voice behavior. Thus this study is an attempt to address this gap by*

taking both types of voice, i.e. promotive and prohibitive.

1.2.6 Hatred as an Outcome of Voice Behavior

Voice behavior tends to point out harmful and wrong practices that are dangerous and unsafe for an organization in the long run, but at the same time, it is considered as a complaint. Literature has suggested that managers rated employees poorly whose voice was more person-centred, and the same employees received increased retaliation by management (Magnus & Viswesveran, 2005). Voice raisers are considered more as trouble makers because it does not offer a solution to the problem (Hung, Yeh & Shih, 2012). Managers, when even devoting time and energy to voice raised, may not support the voice because it is perceived as a threat to their status and position in the organization (Ashford et al., 2009). Similarly, management may not pay attention to employee voice because employees are considered having less knowledge than their management, and employees voice is taken as their self-centred approach (Morrison & Milliken, 2000). Whereas, it has also been emphasized in the latest study by Davidson, Van Dyne, and Lin (2017) that manager and his subordinate expect and reciprocate certain obligations from each other that is it is expected by a subordinate to show loyalty and regard to the boss.

Since there are many advocates of voice and its effectiveness for the organization, there are very few studies that are pointing out the potential consequences of voice for its raisers and its targets (e.g. to whom voice is raised, i.e. manager). Morrison and Milliken (2000) came with interesting findings in their model about organizational silence that employees usually hesitate for engaging in voice behavior when they fear that exhibiting voice behavior can cost them severely. Because, speaking up about something that is not digestible for management may result in hampering relationships and unavailability of resources to them (Kish-Gephart, Detert, Trevino & Edmondson, 2009, Milliken et al., 2003). Recently Hung et al. (2012) stated that this negative relationship between voice and its outcome is very possible to happen in societies that are high on power distance.

People prefer not to engage in a voice that may cause discomfort for others, and

it may make them angry towards employees (Kish- Gephart et al., 2009). Managers often dislike voice because it tends to influence their status, reputation, and prestige within the organization (Ashford et al., 2009). Existing research on the benefits of voice is comprehensive; however, studies investigating how others respond to employee voice is limited. Gap identified from the existing literature is others' responses to employee voice. It is proposed that the manager may develop hatred for an employee who engages in voice behavior. It is more obvious to expect that hatred may be possible more for prohibitive voice because different researchers (e.g. Burris, 2012, Liang et al., 2012) stated that it tends to point out or blame the manager directly, and points out issues rather than the solution to the problem. The supervisor may feel insecure about the input and voice shared by the employee and may develop a negative perception about him (Weiss & Morrison, 2018; Fast, Burris & Bartel, 2014). Burris (2012) notion of challenging voice which is considered to weaken and threaten the existing work practices. Previous research on voice behavior is unclear regarding voice behavior that whether fear before speaking up is justifiable or not.

In contrast, a great deal of research shows mixed results for outcomes of voice behavior (Weiss & Morrison, 2018). Thus voice may be considered as a threat for others at the workplace. Voice behavior has a tendency to disturb the interpersonal relationships with the manager, and it has the risk to irritate higher authorities (Detert & Edmondson, 2011; Burris, 2012). Because Klass et al. (2012) stated that both types of voices tend to raise concern over decisions manager formulated. Secondly, it is also likely to assume that the managerial response would be more directed towards the person who is raising the voice than the voice which is raised. The manager may endorse the voice, but he may not like the person behind that voice and may develop hatred. Managers not only evaluate whether someone is involved in voice behavior, but they sometimes develop negative perceptions about such employees or even punish them (Burris, Rockmann & Kimmons, 2017).

The voice sometimes may result in retaliation from supervisors and may serve as harmful for those who engage in voice, and it may depend upon the supervisor that he may reward or reprimand (Chamberlin, 2017). Previous literature on voice behavior reveals that it not only lacks a more comprehensive systematic

research on outcomes of voice behavior but also that how others socially perceive and attribute those who engage in voice behavior (Weiss & Morrison, 2018). Confronting supervisor with voice behavior is disliked and not welcomed by supervisor and may result in negative consequences and as a result an individual may prefer to stay silent by not engaging in voice behavior to avoid those undesirable repercussions (Prince & Rao, 2021). There is understudied literature specifically regarding upward influence to employee voice behavior (Sheng, 2020). *Thus this study would be an attempt to bridge this gap that how and why managerial hatred is developed for the person who is engaging in the voice that is either promotive or prohibitive. Thus managerial hatred is taken as an outcome of employee voice behavior.*

1.2.7 Perception of Workplace Inclusion and Workplace Exclusion as Outcomes of Voice Behavior

Previous literature on the voice has primarily documented the benefits of voice for organization; however, there is no research showing that how engaging in voice affects employees themselves. While making the distinction between challenge and support oriented voice, Burriss (2012) claimed that individual with challenge oriented voice is likely to get a poor evaluation by the manager because such employees are considered as disloyal to the organization. Challenging voice (e.g. Burriss, 2012) has similar nature as one defined by Liang et al. (2012) for prohibitive nature. Voice behavior is expressed against present poor working conditions and it is inclined to confront the status quo in organization (Parker et al., 2010). So it is always resisted by others in the workplace. Employees may have to experience both types of reactions from others, i.e. positive and negative. So to address this gap, this study is an attempt to extend the literature on the voice that what kind of reaction is possible to each type of voice. Response to voice may depend upon the nature of voice, i.e. whether it is promotive or prohibitive. Promotive voice is related to improvement in existing work practices and procedures that may benefit their organization to adjust to an uncertain and dynamic environment (Van Dyne, Ang & Botero, 2003; Van Dyne & LePine, 1998). Whereas the prohibitive voice

is related to present working conditions, work behaviors, practices and procedures that may damage the organization, and it challenges the status quo (Liang, Farh & Farh, 2012). Burris, Detert, and Romney (2013) add that it all depends upon the others that how they perceive those who are engaging in voice behavior. So from this discussion, it is quite evident that whatever may be the intent of the voice raiser, it is people around him who are going to interpret his/her intention. They may include supervisors, colleagues, or subordinates. Thus others at the workplace can create an environment to show humility to voice raisers and increase their fear of social disapproval (Ou et al., 2014).

Vandewalle, Van Dyne, and Kostova (1995) proposed that voice may have negative repercussions for its raisers because of resistance by other organizational members. It may result in late work promotions and fewer pay raises (Siebert, Kraimer & Crant, 2001). Voice behavior may damage the image of voice raisers because they are viewed as problem creators (Milliken et al., 2003). Voice behavior can also result in poor performance evaluations for employees (Pinder & Harlos, 2001).

A large amount of research on voice behavior has tried to explore contextual as well as individual predictors for voice, however, to better understand voice behavior, it is also crucial to explore its outcomes, especially its implication for those who are going to engage in it. i.e. employees (Weiss & Morrison, 2018). Mor Barak (2011) states that exclusion can be overt or covert. He further adds by distinguishing that overt exclusion refers to behaviors, policies, and practices, whereas covert is related to culture and climates. Thus in many cultures, especially those who are high on power distance, perception of covert exclusion may not be felt by employees as it is already in a culture that employees would be kept at a distance from seniors. However, an overt exclusion would be felt by members because it is more related to behaviors, practices, and policies. Contrary to this discussion, there is a tremendous amount of research insisting that what should be done that may facilitate employees to exhibit voice behavior and that may drive them for voice behavior (Chiaburu, Lorinkova, & Van Dyne, 2013).

There may be various benefits of voice for organizations; however, it may carry negative consequences for those who engage in it (Newman, Donohue & Eva, 2017). Chamberlin (2017) posited that voice could have serious outcomes, especially if

it is about sharing news that is bad in nature. Voice behavior is a form of organizational citizenship behavior, brings change at workplace yet it is risky and considered challenging in nature (Bergeron & Thompson, 2020). Others especially supervisors and managers who have higher power authority and control valuable organizational resources may impact those voice raisers lesser power authority and can make the voice behavior engagement risky (Satterstrom, Kerrissey & DiBenigno, 2020). People may remain silent to avoid risks associated with engagement in voice behavior (Tangirala et al., 2013). Parker et al (2019) posited that voice behavior may have pleasant and unpleasant outcomes for voicer themselves as well as for others and organizations too.

Since there is a difference in both dimension of voice behavior i.e. promotive and prohibitive voice behavior, perception of workplace inclusion and exclusion also differs. Difference in nature of workplace inclusion and exclusion depends upon the nature and content of both of these perceptions. Perceived workplace inclusion refers to individuals own attempts to be a part of organization's dominant groups (Brewer, 1991). Individual intentionally tries to establish quality relationships with others and would engage in activities that may make his familiarity and similarity with others in organization so that his acceptance by others is high and he can achieve the perception of inclusion (Brewer, 1991). Belongingness and connectedness with others and to trying to remain part of workgroups is the basic human need (Maslow, 1965; Mor Barak, 2005; Shore et al., 2011). Perceived workplace inclusion refers to feelings of being respected, connected, heard and comfortable with and valued by others at workplace. Perceived workplace exclusion is something clearly vivid and one can readily recall his experiences of being excluded by others at workplace. Individual is excluded by others. Perceived workplace exclusion refers to the perception of getting silent treatment, rejection, being ignored and being shunned by others at workplace (Leary, 2001; Hiltan, Clifton & Desoton 2006). It is the treatment that one may receive from another individual or group and it influences employees' wellbeing (Hiltan et al, 2006). Perceived workplace exclusion refers to others intentional efforts to to hinder someone from maintaining healthy relationships with others at work, and it also refers to engaging in certain attempts so that others repute at work can be damaged (Hiltan et

al, 2006). Poor psychological health and wellbeing, anger, loneliness, hurt feelings and social anxiety has also been reported as undesirable outcomes of workplace exclusion (Vesalainen, 2017).

Given this generally inconsistent relationship between voice and its outcomes, there is no ample research that has examined perceived inclusion and perceived exclusion as an outcome for voice. *Thus the perception of inclusion and perception of exclusion is taken as outcomes of voice behavior.*

1.2.8 Voice Climate as a Moderator

Wei, Zhang, and Chen, (2015) mentioned in their suggestions for future recommendations that leaders exhibit managerial openness by creating an environment for group-wide effect. Future research should explore group level leadership influences. So this thesis is also an attempt to respond to suggested future recommendations by Wei et al. (2015) by taking the voice climate of organizations. Voice climate is the factor maintained by colleagues at the workplace and may have the support of senior management for maintaining this climate. Voice climate is defined as the degree to which employees consider that they are welcomed to speak and involve in voice behavior (Lee, Wang & Liu, 2017). An organization that does not value employee participation would develop a climate in which employees prefer to stay silent and would choose not to give feedback (Weiss & Morrison, 2018), consequently creating a climate that is low on voice. Employees feel encouraged for engaging in voice behavior when they find a positive workplace climate (Chamberlin, Newton, & Lepine, 2017; Lee, Diefendorff, Kim & Bian, 2014; Morrison, 2014). In a recent study, it has been suggested that to develop employees' creative behavior and to flourish innovation at work, a climate of trust and safe working conditions should be created (Berg et al., 2017). Researchers like Burriss, Roackmann, and Kimmons (2017) have indicated that it is actually the role of leaders in the creation of an environment that is more inclusive and open for speaking up and which is considered safe by employees. Consequently, they feel secure to volunteer their improvement-oriented concerns and voice. So leadership also plays its role in creating, maintaining, or vanishing the environment for voice climate.

Another recent study encouraged in their future directions to study that how voice can be promoted by setting an environment that is high on expectations to voice and that can shape voice perceptions (Duan, Li, Xu & Wu, 2016).

A large number of studies have explored individual-level factors to explore proactive behaviors and have overlooked collective level factors at a more considerable extent to study proactivity, so future researchers should explore group and collective levels factors to study proactivity (Lebel, 2017). Voice climate is a factor that is maintained at the group and collective level.

This thesis has taken voice climate as a moderator between cognitive motivational state and affect related process i.e. felt obligation for constructive change and emotion regulation respectively and both types of voice. As Davidson et al. (2017) emphasized that when employees are afraid of repercussions of speaking up, they less engage in voice, and on the other hand, when they perceive, that their voice may be given some consideration, it increases their tendency to engage in voice. Despite the various benefits of employee voice for the organization, one of the factor due to which employees are hesitant to exhibit voice behavior is fear of undesirable social repercussions because of employees perception that others at the workplace (e.g. supervisors and managers) would react negatively and may develop a negative image of them (Weiss & Morrison, 2018). Workplace high on voice climate helps employees to reduce their anxieties associated with voice behavior and in such a climate there is a lesser risk to their careers and the threat to their interpersonal relationships (Hsiung & Tsai, 2017).

Thus it is the climate at the workplace that may smooth or hinder the possible outcomes of voice. Hsiung and Tsai (2017) further extend that speaking up may have potential benefits for an organization's improvement. Still, at the same time, employees have to assess the climate for favorability of voice behavior. Whereas Parker, Bindl, and Strauss (2010) also discussed the role of context in the form of a possible moderator for proactive behavior. So it is an organizational climate that may play a crucial role behind the various occurrence of voice. At the same time, this study has taken both types of voice, i.e. promotive and prohibitive voice as proactive behavior. Madrid (2020) proposed for future researchers to study the

emotion regulation by interacting it some contextual variables to study its role in prediction of voice behavior. In a recent study on voice behavior's effectiveness for organizations, it has also been suggested to study voice climate as the moderator (Um-e-Rubbab & Naqvi, 2020).

In another study by Bergeron and Thomson (2020), it is stated that voice climate may influence an employees' tendency to engage in voice behavior at individual and group levels. Voice climate may influence voicer behaviors and it may also impact the outcomes (Satterstrom, Kerrissey, DiBenigno, 2021). Parker, Bindl, and Strauss (2010) discussed the role of context in the form of a possible moderator for proactive behavior. So it is an organizational climate that may play a crucial role behind the various occurrence of voice. At the same time, this study has taken both types of voice, i.e. promotive and prohibitive voice as proactive behavior. *So voice climate is taken as a moderator between cognitive motivational and affect related processes with voice behavior which has also been suggested by (Parker et al. 2010) in proactive behavior model theory.*

1.2.9 Emotion Regulation as a Mediator between Personality, Situation-Specific Antecedents, and Voice Behavior

Most of the previous research on emotion regulation is conducted in a western context and is generalized universally, but there are cultural differences, emotion regulation should be interpreted accordingly (Trommsdorff & Rothbaum, 2008). Similarly, some other scholars also argued that emotion regulations, as well as expression of emotions, may depend upon cultural self (Mesquita & Markus, 2004; Markus, Mullally, & Kitayama, 1997) thus emotion regulations develop and adapts according to the conditions of cultural context. Cultures can not be considered as homogenous systems (Oyserman, Coon, & Kemmelmeier, 2002). It is quite understandable to evaluate that emotion regulation may vary between cultures. Most of the previous research on emotion regulation accounts for enhancing positive emotions and refraining from negative emotions for improving one's well-being

(Trommsdorff & Rothbaum, 2008). There is a lack of research on emotion regulation in the context of voice behavior for employees. Emotion regulation regulate emotions and helps individuals to interact with others effectively (Kazemitabar, Lajoie & Doleck, 2021). Because emotion regulatory mechanism is an essential factor behind the decision to speak up, especially when it is for the betterment of the organization and its functioning. Similarly, core self-evaluation, as regulators of emotion, has also been largely ignored as the impact of both is different for eliciting emotional responses.

Emotions arise when people face a situation, and then they accordingly evaluate it whether it is relevant to their goals (Mauss, Bunge & Gross, 2007). Schutz et al. (2011) illustrate emotion that a critical aspect of emotions is the judgment of a situation that what is happening in a particular transaction of person and environment. They further extend their notion about emotions that a person may assess his position in the context of his own goals and where he wants to be.

Pleasant or unpleasant emotional experiences tend to provide multidirectional feedback to other processes that are involved in self-regulation. Thus the process of engaging in voice behavior is motivated and behaviorally active because of the self-regulation of emotions (Zimmerman, 2001). Emotion regulation can maintain, reduce, or strengthen one's emotions depending upon his/her goals (Gross & Thompson, 2007). Thus if the goal is the attainment of personal success through engaging in proactive behavior, i.e. voice behavior or the goal is correction and improvement of organizational functioning, emotion regulation would guide him to engage in promotive or prohibitive voice behavior. This argument is supported by Schutz et al. (2011) that emotion regulation is composed of different processes which include monitoring a situation evaluating it and then modifying emotional experience.

Previous studies on emotion regulation emphasized different consequences of emotions (Gross, 2001). In a recent study, it has been suggested to explore how negative emotions influence the proactivity of employees at work (Lebel, 2017). Lebel, (2017) further adds that negative emotions may help an individual to visualize and plan, but they do not make an individual perform that behavior. He

suggested that future researchers should explore the underlying mechanism of such behaviors over proactive behavior.

Parker et al. (2010), in their proactive behavior theory, argues that proactive behavior needs to be fueled not only by a cold motivational state but by hot motivational states. Thus emotion regulation is affect related process consisting of can do, reason to do, and energized to do states consistent with monitoring a situation evaluating it and then modifying emotional experience (Schutz et al., 2011).

Identification of an effective form of emotion regulation is an important goal that needs the attention of future researchers (Soric et al., 2013). Emotion regulation, as described by Yildiz (2016), is the mechanism of adaptation to challenges of one's routine life, and it helps people to preserve their wellbeing by reaching a higher-level goal. He further adds up about the nature of emotion regulation as consisting of two types which are positive. Proactive behavior i.e. voice behavior is fostered by contextual variables out of which one can be emotion regulation (Bohlmann, Rudolph & Zacher, 2021; Parker, Wang & Liao, 2019). Madrid (2020) proposed that emotion regulation can be the reason behind employees' involvement in voice behavior and emotion regulation has been a very neglected variable in research on voice behavior as the possible predictor of voice. *People of Asian cultures may be more prone to either accept or maintain negative emotions. They may not try to reduce them, so future researchers are required to focus on differences in culture to better understand emotion regulation (Nakagawa, Gondo, Ishioka & Masui, 2017). This study is taking emotion regulation as a mediator between personality, situation-specific antecedents, and voice behavior. Similarly, emotion regulation has also been taken as an outcome of these antecedents responding to the suggestion (e.g. Soric et al., 2013; Nakagawa et al., 2017).*

1.2.10 Perceived Risk as a Moderator between Voice Behavior and its Outcomes

Burris, Detert, and Romney (2013) add that it all depends upon the supervisors that how they perceive those who are engaging in voice. If supervisors perceive

their idea as constructive and valuable, they are considered to get the better evaluation, whereas when employee's voice is regarded as not productive, they are likely to perceive poor evaluation by supervisors. Thus it all depends upon significant others around voice raisers, that how they interpret the intent of voice raiser so voice raiser would also try to avoid this negative interpretation about him/her and would engage in a conscious attempt to develop a positive perception about him/her. Given this generally negative relationship between voice and its repercussion for employees as well as positive outcomes, there has been no ample research that has examined this mechanism that why employees are reluctant to share their concerns and what perceptions they built because of engaging in voice. Employees exhibit promotive voice behavior only when they consider engaging in it worthwhile (Wei, Zhang, & Chen, 2015). Whereas as far as prohibitive voice is concerned, employees only exhibit prohibitive voice when the perceived risk associated with it is low. They further emphasize future scholars to disentangle other organizational and individual factors. This thesis has taken a perceived risk as a moderator between both types of voice and outcomes. Thus it can be assumed from existing work on literature that it is actually own perception of employees about risk depending upon the outcome he/she has to face as a result of engagement in voice behavior. As Davidson et al. (2017) emphasized that when employees are afraid of repercussions of speaking up, they less engage in voice. Despite the various benefits of employee voice for the organization, one of the factor due to which employees avoid engaging in voice behavior is fear of undesirable social outcomes because of employees perception that others at the workplace (e.g. supervisors and managers) would react negatively and may develop a negative image of them (Weiss & Morrison, 2018) that is exclusion from colleagues and hatred of manager in this case.

Speaking up may have potential benefits for the organization's improvement but at the same time employees have to calculate the associated risk and have to incur the cost (Hsiung & Tsai, 2017). In a recent study, it has been suggested to explore how negative emotions influence the proactivity of employees at work (Lebel, 2017). He suggested that future researchers should explore the interacting mechanism of such behaviors over proactive behavior. Perceived risk tends to carry negative emotions.

In a recent study on voice behavior by Duan, Lapointe and Xu (2019), role of perceived risk regarding voicing has been emphasized too. It can be worthwhile to study perceived interpersonal risk while engaging in voice because speaking up is contingent upon suggestion or idea being shared (Bergeron & Thompson, 2020). *This study is an attempt to find out how voice behavior and its situational judgment, i.e. perceived risk interact with each other outcomes of voice. Thus it is a perceived risk that may strengthen or weaken the relationship that exists between voice behavior and its outcomes. Therefore this study is an attempt to address this gap that how perceived risk works as a moderating mechanism for eliciting various responses.*

1.2.11 Validation of Perceived Risk

Wei et al., (2015) though developed the measure of perceived risk by using the perceived relationship costs scale from the studies of conflict about different concerns and fears for voice. Final items showed results of conflicts with the target person that was more related to prohibitive voice than the promotive voice. Studies showed that perceived risk for both these voices damage relation (Milliken et al., 2003; Morrison, 2011), but still work is required to refine as well as to validate this scale (Wei et al., 2015). Similarly, this scale would be used to assess the perceived risk that employees encounter and which acts as an intention to avoid or cater to the outcomes of voice behavior. Employees are more prone to engage in voice behavior when they can avoid the risk associated with raising voice (Burris, Detert, & Chiaburu, 2008). Employees may ponder and evaluate the risk associated with each type of voice before actually engaging in voice behavior. As this has already been discussed that both types of voice are different.

Promotive voice is related to improvement in prevalent work behaviors, practices, and procedures which might benefit their workplace to adjust in an uncertain environment, and the prohibitive voice tends to challenge the status quo (Van Dyne, Ang & Botero, 2003; Liang, Farh & Farh, 2012; Van Dyne & LePine, 1998). Both emotional and rational factors play their role in decisions to speak up, and employees always evaluate their social context for the favorability of their voice

behavior to assess the perceived risk (Hsiung & Tsai, 2017). Employees often are reluctant and hesitant for their voice behavior because of their perception that it can be risky and unsafe to share their opinion (Agnihotri, 2017).

So perceived risk would be differently associated with each type of voice and for their outcomes. Thus summarizing these arguments; it is actually about the perceived risk associated with both types of voice. The scale measuring the intensity of perceived risk for both types of voice would help future researchers to quantify and assess the psychological mechanism and costs associated with both types of voice behavior, i.e. promotive voice and prohibitive voice. *Thus this study will cover this gap by refining this scale of perceived risk in the context of the relationship of promotive and prohibitive voice with their outcomes.*

1.3 Problem Statement

Different antecedents of voice behavior have extensively studied in the near past due to its importance, but limited studies have focused on outcomes of voice behavior. It has also been studied that voice behavior results in positive organizational outcomes. However, there are very few studies that have explored how voice behavior impacts the employees' own perception because if they are perceived negatively by others because of voice behavior, it will reduce the chance of their involvement in voice behavior in the future. Consequently, low involvement in voice behavior by employees would result in poor detection of flaws and errors in organizational policies and employees would not bother for improved functioning of their work and better functioning of their organization.

Most of the work on fruitful outcomes of voice has been studied in a western context where power distance is low. The findings of such studies cannot be generalized in eastern contexts where power distance orientation is high and where speaking, specifically against wrong practices followed in organizations is a real challenge for employees. So this study is an attempt to explore the impact of voice in a context-specific setting in an underdeveloped country like Pakistan. In many countries

like Pakistan, where western theories are practiced without carefully knowing the fundamental difference that lies on the continuum of power distance, this study is one of the empirical testing of the outcome of voice behavior for employees. Therefore, the dual-process model of voice in terms of its antecedents and outcomes will provide significant insight into the flourishing literature of employee voice in the context of Pakistan.

1.4 Research Questions

The present study is aimed to find out the answers to the below-stated questions based on the above-mentioned problem statement:

Question 1:

What is the impact of core self-evaluation and supervisory delegation as individual and situational factor in generating employee proactive behavior i.e. voice behavior?

Question 2:

What is the role of cognitive motivational state and affect related process i.e felt obligation for constructive change and emotion regulation respectively as possible mediators between individual factor i.e. core self-evaluation, situational factor i.e. and supervisory delegation and their outcomes i.e. both dimensions of voice behavior.

Question 3:

What is the impact of employees' proactive behavior i.e. voice behavior in generating the perception of managerial hatred, perceived inclusion, and perceived exclusion?

Question 4:

What is the role of work context i.e. voice climate as a moderator for the relationship between cognitive motivational state and affect related process i.e. felt obligation for constructive change, emotion regulation and proactive behavior i.e. both dimensions of voice behavior?

Question 5:

Whether perceived risk moderate the relationship between proactive behaviors i.e. voice behavior and its outcomes.

1.5 Research Objectives

The ultimate objective of this study is to explore the antecedents and outcomes of employee engagement in promotive and prohibitive voice behavior. Based on proactive work behavior theory, the present study is aimed to find out different motives of an employee exhibiting and withholding voice behavior in organizations, as well as the aftermath of such behavior. The detailed objectives of the present study are stated below:

- To identify the role of individual and situational factors that are core self-evaluation and supervisory delegation respectively for employees' engagement in proactive behavior i.e. both dimensions of voice behavior.
- To assess the role of cognitive motivational state i.e. felt obligation for constructive change, and affect related process i.e. emotion regulation as the potential mediators between individual factor i.e. core self-evaluation, situational factor i.e. supervisory delegation and their outcome i.e. proactive behavior in the form of both dimensions of voice behavior.
- To evaluate the outcomes of employee proactive behavior i.e. both dimensions of voice behavior in the form of perceived managerial hatred, perceived workplace inclusion and perceived workplace exclusion.
- To explore the role of work context i.e. voice climate as the moderator for the relationship between cognitive motivational state and affect related process i.e. felt obligation for constructive change, emotion regulation respectively and proactive behavior i.e. both dimensions of voice behavior.
- To evaluate the role of perceived risk as the moderator between proactive behaviors i.e. both dimensions of voice behavior and outcomes for employees that are managerial hatred, perceived workplace inclusion and perceived workplace exclusion.

1.6 Significance of the Study

Theoretical and practical significance of the study has been described with the help of proactive behavior theory (Parker et al, 2010).

1.6.1 Theoretical Significance

With a high level of uncertainty and increasing demands for innovation, the voice behavior of employees has become an essential element of organizational survival (Parker & Collins, 2010). Due to its pivotal role, a large number of studies are conducted and are still called by different researchers to explore its antecedents and outcomes for further conceptualization that particular phenomena. Both researchers and practitioners are interested to know more about the voice behavior of employees to reap the full advantages of such contribution on the part of employees. In this aspect, the present study offers some theoretical and contextual input in the form of some antecedents and outcomes of voice behaviors.

The present study offers that supervisory delegation will promote voice behavior through the pathway of felt obligation for constructive changes. In the past multiple contextual, dispositional, and motivational states like leadership, career unit orientation/work unit orientation, approach motivation, etc. were used to predict voice behavior of employees (Aryee, Walumbwa, Mondejar, & Chu, 2017; Wu, Parker, Wu & Lee, 2018). The present study will enhance the understanding of the researcher to predict voice behavior through other motivating dispositional and situational factors.

The present study is focusing on both situational and dispositional antecedents of voice behavior of employees. Previously researchers have also tried to explore both positive and negative predictors of voice behaviors in the form of approach and avoidance motivation (Tangirala et al., 2013). The present study will further expand the understanding that how core self-evaluation of employees as dispositional factors and supervisor delegation as situational factors lead to both promotive and prohibitive voice through the explanatory mechanism of felt obligation for constructive change and emotion regulation.

The most important contribution is in the form of the moderator of voice climate, which influences the relationship of felt obligation for constructive change, emotion regulation, and voice behavior. Voice climate encourages employees to speak up and accordingly would be the environment in which people find themselves more comfortable to engage in voice behavior. It would help organizations to design their climate accordingly, which is high on expectations for voice to reap the full benefits of voice behavior.

Researchers are very keen to explore the outcomes of voice behavior because voice behavior is against the norms of group and status quo. They are not considered socially desirable, due to which employees consciously decide before indulging themselves in such behaviors. The present study has explored the two expected positive and negative outcomes (i.e. perceived workplace inclusion and perceived exclusion) of voice behavior which will provide an in-depth insight for the researchers to investigate other avenues in the future.

Effectiveness of employee voice behavior has always been preached for the organization that it has long-lasting benefits for the workplace. However, the number of studies that have explored the impact of voice over managers that how they respond to employees who engage in voice behavior is considerably less. This study is going to examine the outcomes of voice through hatred managers may develop for voice raisers. As not forgetting the phenomenon, that voice is always targeted at the manager.

1.6.2 Practical Significance

Furthermore, studies on voice behavior are mostly conducted in developed countries, and developing countries like Pakistan lack empirical studies on employee voice. Pakistan has high power distance and collectivist culture (Hofstede, 1980), so the voice behavior of employees is not supposed to be encouraged by immediate supervisor and other group members. Therefore, it's essential to understand and find out antecedents of voice behavior in such a contextual setting, to find out the different motivational and attitudinal mechanisms to promote the voice of employees.

This study may help organizations and managers to understand that employees may differ on the degree of core self-evaluations. Organizations should develop such interventions and strategies that may help people to engage in voice behavior because of their increased utility for the long term survival of the organization. Findings and the proposed relationship between study variables would help the organization to design jobs accordingly that how supervisory delegation might help employees to involve in voice behavior. This would also help managers to understand that how a greater sense of responsibility can be transferred among employees by crafting organizational and supervisory structures.

Findings and relationship of both types of voice behavior that are promotive and prohibitive with negative and positive outcomes would help organizations to understand that if exclusion and managerial hatred are more associated with prohibitive voice, it might decrease employees' engagement in voice behavior. Consequently, organizations can not prevent themselves from loss and harm because they would lack people who can point out such unhealthy practices and procedures. So organizations should develop such strategies and interventions which are equally important for employee's engagement in both dimensions of voice behavior.

1.7 Supporting Theory

Different theories like affect control theory, expectancy theory, social information processing theory, and socially desirable responding theories are used worldwide to build a framework of proactive behaviors. But a model of proactive motivation presented by Parker, Bindl, and Strauss (2010) can be used as an overarching framework for the present study due to its influencing nature in the studies of proactive approaches.

1.7.1 Overarching Theory

Theory of proactive motivation of Parker, Bindl and Strauss (2010) has been used as an overarching support for the said model of the study.

1.7.2 Theory of Proactive Motivation

Parker, Bindl, and Strauss (2010) states that engagement in proactive behavior is not safe; it's because proactive behavior is actively engaging in unknown activities that outcomes are not specific. Proactive behavior is that sort of behavior that is against the present state of working and such changes are resisted by colleagues, supervisors, and subordinates as well. Therefore, proactive behavior is not as simple as other normal courses of action. It needs some driving forces that motivate people towards proactivity.

According to Parker, Bindl, and Strauss (2010), model proactivity is mainly based on two perspectives, i.e. proactive goal generation and then striving for those proactive goals. They have also identified a range of proactive goals along with can do, motivation to do, and energized to do motivational conditions for generation and striving for these goals.

1.7.3 Proactive Goal Generation

Proactive goal generation is based on two major perspectives (Envisioning & Planning). Firstly envisioning of proactive goals, which refers to perceived opportunities in the present and also in the future that can be grabbed through active engagement. Envisioning is based on a cognitive mechanism that focuses on forecasting an imaginary future and some desirable outcomes. Through the mechanism of envisioning individual seeks to achieve three different desirable future states. Firstly, they try to develop a person-environment fit by creating a match with the environment in terms of demands, supplies, and values. Secondly, they try to improve the internal organizational environment. It can be enhanced through problem-solving and improving working conditions at the individual, team, and organizational levels. Last, they think strategically and try to develop a match between the organization and the external environment. While the planning stage of proactive goal generation is to decide a course of action to achieve the envisioned future. Envisioned future can be attained through change oneself in terms of performing tasks, using skills and methods, or by changing external conditions like modifying other behaviors, change the working environment, etc.

1.7.4 Proactive Goal Striving

Proactive goal striving is the individual cognitive and behavioral tendencies for the accomplishment of generated proactive goals. Only generating proactive goals are not enough, but through proactive goal striving individual can bring change in himself as well as in the situation. Bindl and Parker (2009) identified that proactive goal striving is based on two major elements. These are enacting and reflecting. Enacting involves influencing colleagues and making alliances for changing the situation. It also stresses on self-regulatory focus rather than a detraction from the proactive goals. Enacting is all about sheer determination and persistent efforts to change oneself and the situation. While reflecting the element of proactive goal striving is the individual attempt to identify and understand the consequences of proactive behavior. Such understanding and information help individual in changing his/her behavior and situation for the achievement of proactive goals.

Proactivity is all about making things in your way, forecasting the unseen problems and taking steps to eliminate them, and grabbing the opportunities. It's actually to bring changes in the work setting or to change future outcomes. Parker, Bindl, and Strauss (2010) theory revolves around proactive goals generation and striving for achievement of these goals. After comprehensively discussing Parker, Bindl, and Strauss (2010) summarize all the widespread prevailing literature and propose can do, the reason to do and energized to do framework for proactive goal setting and proactive goals striving. The first driver is the "can do" thinking of an individual. Multiple theories also support the can-do of individuals; like self-efficacy theory, expectancy theory, and control theory. Parker, Bindl, & Strauss (2010) argue that "can-do" motivation is based on individual self-efficacy, his attribution, and perception about the cost of action.

Based on the self-regulation theory perspective, individual set proactive goals willingly by assessing the consequences of that behavior in pursuit of these goals (Parker, Williams, & Turner, 2006). Setting a proactive goal or decision to engage in proactive behavior needs a high level of self-efficacy because being proactive is quite risky. The main reasons for such risks are the negative (belief) of others and their resistance to such behavior. Therefore it needs self-confidence while behaving

proactively to control all the relevant risk factors.

”Can do” belief of individuals are not sufficient to involve in proactive behavior, there is also a need for strong motivational drivers that can be perceived value-driven as an outcome of proactive behavior. They name it Reason to do motivational state; it’s actually the utility judgment of individuals about the outcome of proactive goals. Drawing from the self-determination theory, (Deci & Ryan, 2000), they state that proactive behavior is based on autonomous motivation because they are self-initiated and need a strong reason of motivational forces to engage in such behavior. Autonomous motivation is based on intrinsic drivers and integrated forces for the achievement of some desirable future.

Parker, Bindl, and Strauss (2010) named can do and reason to do motivation as cold motivational states, they further argue that only cold motivational drivers are not enough to engage in proactive behaviors. Hence, there is a need for hot motivational drivers for proactive behavior. Russell, (2003) states that the core influence of any behavior is based on valence and activation towards these. Along with can do and reason to do, positive affective states also helps in setting challenging goals and their achievement. Based on these arguments Parker, Bindl, and Strauss (2010) add distal factors and also the direct effect of positive affect on the setting and motivation for achievement of these goals. Therefore it is stated that positive effects like motivation, vitality, and enthusiasm trigger the proactive action of individuals.

Parker, Bindl, and Strauss (2010) propose different individual and contextual factors that can influence these motivational states. Individual differences like proactive personality, aspiration for control, values of individuals towards change, future-focused thinking, emotional regulation and confidence belief and personality traits like conscientiousness, etc. are fueling the can do, the reason to do and energized to motivation states. Along with those, personal background, education, and skills are essential factors for enhancing motivational states. While contextual factors like leadership, organizational climate, and social processes are also encouraging factors to trigger the motivational states. These proactive motivational states help in proactive goal setting and striving for the achievement

of these goals. These goals may be aimed at developing person-job fit, improving organization functioning, and improving the strategic fit of organizations. The outcomes of these proactive goal processes can be in the form of change in the environment or change in self. Furthermore, they state that contextual factors can affect the path between proactive motivational states and proactive goal processes.

In the present model, individuals generate proactive goals in the form of voice behavior. Individuals envision promotive and prohibitive voice in order to create a person-environment fit, improving organizational functioning by resisting bad practices and presenting ideas for improvement as well as improving organizational practices for achieving its strategic objectives. For such purposes, they try to change the external situation through voice behavior. Along with this through promotive and prohibitive voice individual strives to achieve proactive goals through enacting and reflecting. During the enacting stage, they try to persuade others for the improvement of organizational practices by changing working conditions, and through reflecting they forecast the consequences of voice behaviors in the form of managerial hatred, perceived work inclusion and exclusion, and organizational performances.

Parker, Bindl, and Strauss (2010) can do, motivation to do and energized to do, motivational states are presented in the form of felt obligation for constructive change and emotion regulation of employees. Felt obligation for constructive change may serve as a cold and emotion regulation serves as a hot motivational proactive state based on can do, motivation to do, and energized to do motivation of employees. It may help in proactive goal generation and proactive goal striving in form promotive and prohibitive voice.

Whereas supervisory delegation is a managerial factor that enhances a proactive motivational state for felt obligation for constructive changes. In line with Parker, Bindl, and Strauss (2010) framework voice climate is playing a moderating role in effecting the proactive goal processes. Combining the effect of individual, managerial, and contextual factors will be significant drivers in enhancing can do, the reason to do and energized to do motivational states of an individual which will results in feeling obligations for constructive changes and regulating their emotions

accordingly to engage in voice behavior.

In the present study, core self-evaluation is a personality factor that may enhance a proactive motivational state by engaging employees in the felt obligation for constructive change as well as regulating their emotional state. At the same time, their cold and hot motivational processes (felt obligation for constructive change and emotion regulation) fosters depending upon their decision to engage or not in voice behavior. This mechanism of motivational states will result in proactive goals setting and striving for achievement of these goals. Such goals can be in both forms of voice behavior. Promotive voice will be aimed at developing internal processes and achieving strategic fit while prohibitive voice will result improve the current functioning by blocking the non-value-added factors. Thus felt obligation for constructive change and emotion regulation will mediate the relationship between outcome and antecedents. While the outcome of these voice behavior can be in the form of change in an organizational environment like withdrawal or extension of support from others in the form of work inclusion or exclusion and hatred from the manager.

Parker et al. (2010) in their work further added in future directions for scholars that they have not exhaustively documented on outcomes of proactive behaviors because the outcomes of proactive goal processes are uncertain. They posited that it is not necessary that proactivity would always bring positive outcomes in the form of a positive evaluation by the supervisor. Still, sometimes it may lead to negative outcomes because proactive goal processes are against status quo positions which are not often encouraged. Thus they have suggested that outcomes of proactivity need to be considered deeply. This research is extending their work by taking managerial hatred and perceived inclusion and perceived workplace exclusion as a result of employee engagement in proactive goal processes (e.g. those engaging in voice behavior). Employee perceived risk is taken as possible moderator as per proactive behavior theory (Parker et al, 2010) as appropriateness of behavior. It is assumed that employees after engaging in promotive voice behavior and prohibitive voice behavior would assess the appropriateness of their behavior through their perception on risk about outcomes of voice behavior. It is assumed that employees who have higher perception for risk are more inclined to perceive

hatred from manager. Similarly employees who better perceive risk of perceived exclusion are more likely to feel it after engaging in any dimension of voice behavior. Same is the case with employees' perception of workplace inclusion that if they have not perceived risk for outcomes of voice behavior, they are less likely to be included. Employees tend to perceive the risk in terms of poor relationship with others and retaliation from others after engaging in any dimension. Now employees' perception on risk may determine their tendency to experience the intensity of experiencing any desirable or undesirable outcome of voice behavior. Proactive behavior theory suggested that proactivity may bring positive outcomes yet the outcomes are not always evaluated positively by others at workplace (Parker et al, 2010) This is because proactive individuals may lack judgement of situation and that is especially more worthwhile to note when an individual is high on negative affect or he is experiencing low prosocial motives (Chan, 2006; Grant, Parker, & Collins, 2009) and vice versa that is individual is high on positive affect or he is high on prosocial motives. This situation itself along with lack of situational judgement about the consequences of proactive behavior i.e. voice behavior may alter the relationship between voice behavior and its desirable and undesirable outcomes. Parker et al (2010) suggested that organizational level factors at wider level and individual level factors at individual level may moderate the effectiveness of proactive behavior. Perceived risk in the form of situational judgement is also consistent with the reflecting phase of proactive goal generation (Parker, et al, 2010) in which individual engaging in proactivity tries to understand and evaluate the outcomes of engaging in proactive behavior.

Chapter 2

Literature Review

This chapter discussed the background of all variables and the literature review on the relationship of Supervisory delegation, CSE, employee voice behavior, and outcomes. The particular chapter also covers the moderating role of voice climate and perceived risk for voice. This chapter reviews the literature on the relationships between hypothesized variables, mediations, and sequential mediations.

2.1 Background of Variables

2.1.1 Supervisory Delegation

Delegation is a form of decision making in which employees are involved as well as employees are assigned responsibilities and authority to complete their tasks and assignments (Yukl, 1998). Delegation is a process in which the supervisor empowers his subordinates so that he can take responsibility for the activities assigned (Bass, 1990). Existing literature states that delegation is one of the core factors of effective leadership (Chen & Aryee, 2007). According to Garvin (2013), successful companies like Facebook and Google use delegation of tasks to attract talent, a technique in which employees feel more relaxed and involved in the decision-making process.

Delegation enables self-direction among employees by giving them opportunities to exercise authority ((Chen & Aryee, 2007). This self-direction further enables

employees to innovate new ways of doing things and to experiment with innovative ideas ((Chen & Aryee, 2007). Organization nowadays are adopting flat and non-hierarchical structures to make delegation more effective and popular (Kastelle, 2013). Delegation is a managerial technique that has the potential to transform the work context (Zhang, Qian, Wang, Jin, Wang & Wang, 2017).

Employees have more freedom to complete their tasks and they experience more satisfaction, increased commitment, and innovative work behavior when are delegated authority and power (Chen, et al., 2007). When employees are delegated, they are more motivated to completion of their tasks and it enhances their expertise and skill development (Uhl-Bien et al., 2000). When employees are delegated they find themselves in an environment that is challenging and requires them to perform their tasks independently and significantly (Zhang, Qian, Wang, Jin, Wang & Wang, 2017). Employees consider themselves as worthy, trusted, and important when they are delegated (Chen & Aryee, 2007).

Delegation makes employees jobs more meaningful and significant for them where they are accountable for the achieved outcomes (Zhang, Qian, Wang, Jin, Wang & Wang, 2017). Delegation has several benefits and some of which given in the literature are that delegation boosts employees self-esteem, enables them to exercise self-direction, enables them to perceive their work as significant, gives them control over their tasks, enhances their self-efficacy perception, and makes them feel more empowered (Thomas & Velthouse, 1990; Chen and Aryee,2007; Zhang, Qian, Wang, Jin, Wang & Wang, 2017; Pierce & Gardner, 2004; Spreitzer,1995).

Delegation of tasks makes employees motivated to further enhance the quality of their work. Delegation is nowadays considered an important element for successful management operations (Jammal, Khasawneh, Hamadat, 2015). It is easy to understand that management alone cannot perform all of the actions, and management would not be left with time to make strategic level decisions if senior management is supervising lower-level employees throughout the day. One reason for supervisory delegation is an enhancement in technology. It is comparatively easy to delegate some of the tasks to next level management because of lower-level employees' expertise over technology. Supervisory delegation is defined as

the transportation of authority to executives from senior management (Dessler, 2016). Supervisory delegation is a process in which tasks and authorities are distributed (Lutgans & Hodgetts, 2004). Delegation makes it easy and performs an essential role in attaining business goals fastly (Jammal, Khasawneh, Hamadat, 2015).

Supervisory delegation is a process in which tasks are assigned to subordinates by making them more responsible for their decisions and giving them more autonomy to exercise their authority without taking approval from the manager (Yukl & Fu, 1999). There are various benefits of the delegation, which are achievement and autonomy, employee entrepreneurial behavior, reduced workload over upper management, and training subordinates for strategic level decisions which subordinates are likely to face at upper levels (Minzberg, 1979; Yukl & Fu, 1999). Delegation of tasks results in more efficient decisions (Ito & Person, 1986). Other benefits include job satisfaction, improved organizational outcomes and effective job performance (Yukl & Fu, 1999; Schriesheim, Neider & Scandura, 1998). Delegation is a process that can be viewed as a mechanism of the healthy relationship between supervisor and subordinate by sending signals of trust and competence to subordinates (Leanna, 1986).

2.1.2 Core Self Evaluation

Core self-evaluation is a dispositional trait defined as one's assessment of specific situations that are influenced by essential appraisals (Attiq et al., 2017). Whereas Judhe, Erez, Bono and Thoresen (2003) defined core self-evaluation is an essential assessment of one's value and success as an individual. It refers to one's assessment of his surroundings to himself and characterized by self-esteem, neuroticism, self-efficacy and locus of control (Ereze & Judge, 2001).

Judge, Bono, Erez, and Locke (2005) defined core self-evaluation as a personality trait structured of four characteristics: self-esteem, self-efficacy, locus of control, and neuroticism. Core self-evaluation has been studied extensively with its relation to other variables such as recognition, job satisfaction, creativity, innovative work behavior, happiness and coworker support (Scott & Judge, 2009; Judge, Locke,

Durham, & Kluger, 1998; Amabile, 1983; Yesil & Sozbilir, 2013; Srivastava, Locke, Judge, & Adams, 2010; Attiq et al., 2017).

Self-esteem refers to an individual's perception of his/own worth, the general value that one gives to himself, and an essential self-evaluation (Baumeister, 1997; Locke, McClear & Knight, 1996; Harter, 1990). Self-efficacy refers to an individual's ability to organize, achieve, or handle challenges in life (Bandura, 1997). It refers to one's judgment of coping with specific situations ((Bandura, 1982). An individual who would attempt to avoid difficult tasks and believes more in negative results possess lower self-efficacy (Bandura, 1994). It refers to a degree to which an individual evaluates his ability to meet demands and completes his/her tasks (Xanthopoulou et al., 2009).

Locus of control refers to an individual's thinking pattern regarding his control over success and failure in life. It can be external or internal in nature where the external locus of control means that whatever good or bad happens to an individual is out of his control. Internal locus of control is interpreted as whatever happens to an individual; it is because of his control over events (Rotter, 1966). People with an external locus of control give credit to fate when something good happens to them, or something terrible happens. Locus of control refers to one belief of how much he/she has control over life events (Judge et al., 2005). Neuroticism refers to emotional stability. An individual inclines to notice, monitor, and gauge life events (Eysenck & Eysenck, 1968). Neuroticism is considered as opposite to self-esteem (Barrick & Mount, 1991). Highly neurotic individuals are usually less satisfied with the job (Furnham & Zacherl, 1986). People with neuroticism are more prone to show anger, nervousness and resentment. Neuroticism refers to having emotional instability and negative mentality, and individual with lower emotional stability exhibit more depression, anger and anxiety.

People with higher core self-evaluation are more likely to exhibit self-esteem, self-efficacy, lower neuroticism, and an internal locus of control. In contrast, individuals with lower core self-evaluation tend to show lower self-esteem levels, higher neuroticism, lower self-efficacy, and an external locus of control (Judge et al., 2005). People with higher core self-evaluation appraise themselves higher, are more confident and think positively of themselves. Core self-evaluation is considered a

higher-order trait comprised of four related characteristics: locus of control, self-esteem, neuroticism and generalized self-efficacy (Zhang, Wu, Miao, Yan & Peng, 2014).

People with higher core self-evaluation are likely to interpret their job characteristics more favorably and emphasize less on unfavorable information (Tims & Akkermans, 2017). Core self-evaluation predicts work engagement and has a positive relationship with motivation and performance (Erez & Judge, 2001).

2.1.3 Voice Behavior

Employee voice behavior has become significant as it can enhance organizational effectiveness and optimization (Janssen & Gao, 2015; Gollan & Wilkinson, 2007). Voice behavior can enhance employee productivity and performance (Wilkinson, Dundon, Marchington, & Ackers, 2004). Whereas according to Gollan and Wilkinson (2007), voice behavior helps to identify problems and influences employee's quality of work. Existing literature on voice behavior suggests that voice behavior has been associated with improved decision-making, learning, performance, adaptability, and several other organizational outcomes (Morrison & Milliken, 2000; Bashshur & Oc, 2015).

Employee voice behavior is given importance because it influences the performance of employees, and there has been found positive as well as a negative association between voice behavior and performance (Hung, Yeh, & Shih, 2012; Bashshur & Oc, 2015; Timming & Johnstone, 2015; Ng & Feldman, 2012; Hung et al., 2012). One reason behind mixed results of voice behavior is the nature of voice, i.e., promotive voice and prohibitive voice (Liang, Farh & Farh, 2012; Kakkar, Tangirala, Srivastava, & Kamdar, 2016; Morrison, 2011; DiRenzo, Xu, & Duan, 2014). Liang et al. (2012) conceptualized voice more broadly as promotive voice and prohibitive behavior. Many other studies have adopted mainly this framework (Song et al., 2019; Kakkar et al., 2016; Kong et al., 2017; Ward et al., 2016). There are significant differences between both types of voice, i.e., promotive and prohibitive voice (Song et al., 2019).

Promotive voice is defined as the expression of suggestions or ideas by employees with the intention to improve the functioning of an organization or work unit (Liang et al., 2012). Kong et al. (2017) supported that intention behind the promotive voice is good, easily recognized. Engagement in a promotive voice generates plenty of new ideas and solutions to problems (Qin et al., 2014). Employees who engage in promotive voice behavior gain more support from their seniors. They have more access to resources, including their supervisor's time and attention to reach their goal (Song et al., 2019). Promotive voice behavior is more suggestion oriented with intention. Promotive voice behavior is the expression of innovative ideas for enhancing organizational effectiveness (Song et al., 2019). Promotive voice behavior is more future-oriented, focused on ideal organizational states (Svendsen, Jonsson, & Unterrainer, 2016). Promotive voice behavior aims to improve work practices by further strengthening organizational ways to improve future performance by recognizing new ways for improved success (Kakkar, Tangirala, Srivastava & Kamdar, 2016; Liang, Farh & Farh, 2012).

Prohibitive voice behavior is defined as an expression of concern by the employees about work practices, incidents, or behaviors detrimental to an organization (Liang et al., 2012). Liang et al. (2012) further extend about prohibitive voice behavior as past and problem oriented because of its potential to identify harmful factors. Prohibitive voice is a show of concern for factors that serve as a check for teams' development, and it does not always indicate solutions but the problems (Song et al., 2019). Prohibitive voice is considered past-oriented in nature, which points out the issues and problems in existing organizational practices (Svendsen, Jonsson, & Unterrainer, 2016). Whereas unlike a promotive voice, the prohibitive voice does not offer exact solutions to the problems identified (Liang et al., 2012). Prohibitive voice behavior identifies factors that may harm team effectiveness (Song et al., 2019). Prohibitive voice behavior aims to avoid organizational deterioration that is possible through organizational practices (Liang et al., 2012; Kakkar et al., 2016). Liang et al. (2012) suggest that both of these voices are different in their nature and intend to engage in and overall functioning. However, both promotive and prohibitive voice behavior can benefit their teams (Kong, Huang, Liu & Zhao, 2017).

2.1.4 Felt Obligation for Constructive Change

Felt obligation for constructive change is defined as an employee's belief that they are responsible for creating positive change in the organization (Fuller, Marler, & Hester, 2006; Ward, 2013; Morrison & Phelps, 1999). Liang, Farh and Frah (2012) has expressed the same, that felt obligation for constructive change is an employee's psychological state in which he considers himself as personally responsible for constructive change at the workplace.

Felt obligation for constructive change is when the employees felt responsible for expressing positive concern (Fuller et al., 2006). Employees with a greater sense of responsibility are more likely to engage in voice behavior specifically for the betterment of the workplace (Liang, Farh & Farh, 2012). Felt obligation for constructive change has also been considered an important psychological factor behind voice behavior (Withey & Cooper, 1989; Fuller et al., 2006; Morrison & Phelps, 1999). One reason behind higher felt obligation for constructive change is employee's higher access to organizational resources (Fuller et al., 2006), enhancing an employee's propensity to be more obligated. Employees with more felt obligation perceive it as their way of concern for the organization (Liang et al., 2012).

Some of the factors as antecedents of felt obligation for constructive change are linked to the workplace's structural and social aspects such as autonomy at the workplace (Fuller et al., 2006). Ward (2013) states that the supervisor and subordinate's dyadic relationship can also instill felt obligation. It can influence the degree to which workers are committed to developing new procedures and correction of problems at the workplace (Fuller et al., 2006). Employees who are at higher levels of felt obligation for constructive change are the ones who consider engagement in voice behavior as a show of concern and care and thus make an attempt to prove themselves as a responsible citizen of the workplace (Liang et al., 2012). Liang et al. (2012) further elaborate on the felt obligation for constructive change that employees reciprocate to the workplace's supportiveness by engaging in FOCC. In contrast, employees with lower felt obligation are less likely to engage in voice behavior. Felt obligation for constructive change refers to the degree to which employees consider themselves socially obligated for suggestions

and attempt to resolve or create constructive changes for the organization (Fuller, Marler, & Hester, 2006).

2.1.5 Voice Climate

Voice climate is referred to as an employee's belief about the safety of a particular context regarding speaking up or giving suggestion and their belief that how their voice would be taken by others (Morrison, Wheeler-Smith, & Kamdar 2011; Morrison & Milliken, 2000). It refers to the degree to which employees perception regarding the display of voice behavior (Lee, Wang & Liu, 2017).

According to Frazier and Fainshmidt (2012), if organizations want to reap the benefits of employees' input through voice behavior, they will have to provide a climate enriched on voice expectations.

Morrison et al. (2011) opinionated that group perception regarding voice climate impacts an individual voice behavior and influences employees' work outcomes. The aim behind voice climate is encouraging employee's engagement in voice behavior and provoking them to be more proactive (Frazier & Fainshmidt, 2012).

Workgroups shared beliefs regarding voice behavior is known as voice climate (Morrison, Smith & Kamdar, 2011). They further argued that these shared perceptions regarding voice could be developed at the workplace. It is the collective perception of employees about behaviors and practices that are encouraged and rewarded at the workplace (Kuenzi & Schminke, 2009). According to Kuenzi and Schminke (2009), this collective belief of workgroups can strongly influence employee behavior.

Group voice climate has two dimensions, which are group voice safety beliefs and group voice efficacy (Morrison, Smith & Kamdar, 2011). Group voice safety is a psychological belief regarding contextual safety regarding interpersonal risk-taking, focusing on perceived safety regarding raising concerns (Edmondson, 1999). Group voice efficacy is the second dimension of voice climate that is shared perception or belief that whether members of the group can raise voice effectively or the group's capability to voice up (Morrison, Smith & Kamdar, 2011). Voice efficacy

is high in groups where group members perceive that their suggestions are taken seriously and vice versa.

2.1.6 Managerial Hatred

Hatred is defined as an act that fallouts due to offensive behavior against someone, and this behavior is considered purposeful from the victim against the perpetrator (Royzman, McCauley, & Rosin, 2005; Halperin, 2008). Hatred is considered to have the potential to create differences among members of in-groups (Shnabel & Utrich, 2016). It is usually targeted at the essential characteristics of a group or an individual (Kristeva, 2011). Many political behaviors aimed at others in the workplace originate from hatred (Halperin, Canetti-Nisim, & Kimhi, 2007). It is a strong continuous feeling resulting in condemning an individual, system or idea (Hoffmann, 2016).

Hatred is characterized into two forms, i.e., intense hatred and mild hatred (Halperin, Canetti & Kimhi, 2012). Halperin et al. (2012) state that intense hatred is more instantaneous, aiming to rout or annihilate out-group members. In contrast, mild hatred is more chronic in nature resulting in complete rejection of out-group members associated with negative feelings. It is a stirring intoxicated force (Stenberg, 2000; Bar-Tal, 2007). Hatred is hostile in nature, consisting of feelings of malice and dislike-ness intended to harm another individual or group (Stenberg, 2005).

Hatred is characterized as hot emotion (Halperin, 2008). It is a negative feeling which produces segregation among people of in-group and out-group. It may result in perpetrators' intense acts, including sabotaging the victim or involvement in violent acts against victims and ethnic purgation (Kressel, 1996; Bar-Tal, 2007; Stenberg, 2003). Hatred is characterized by hostile feelings consisting of malice and disliking with the intention to harm another person or group (Stenberg, 2005). According to Descartes, hatred is a negative evaluation or disgustful feeling with withdrawal behavior about an object (Royzman, McCauley & Rozin, 2005). When an individual is experiencing hatred for another individual, it further progresses,

and the person may engage in violence against the victim person or group (Baumeister & Butz, 2005).

2.1.7 Workplace Inclusion

Systematic research on workplace inclusion was first introduced by Mor Barak and colleagues (Mor Barak & Cherin, 1998; Shore, Cleveland & Sanchez, 2017; Mor Barak, Cherin, & Berkman, 1998). Perceived workplace inclusion is defined as the employee's feeling that he is accepted and included by others at the workplace (Mor Barak et al., 1998; Tang et al., 2015; Frederickson & Cline, 2002; Pearce & Randel, 2004).

Perceived workplace inclusion refers to the degree to which one may consider himself as an important part of organization processes and access to resources and the ability to influence the decision-making process and involved by groups (Mor Barak & Cherin, 1998). It refers to an employee's perception that he is appreciated and accepted by others at the workplace (Chen & Tang, 2018). Perceived inclusion is characterized by employee's perception of acceptance and recognition at the workplace, and it also influences employees positively and enhances their psychological satisfaction (Mor Barak & Cherin, 1998; Robinson et al., 2013).

Work on the concept of inclusion started in recent years (Tang et al., 2015). Mor Barak et al. (1998) explain why some people experience more or less inclusion, and the characterized feeling may influence their self-esteem at the workplace. Perceived workplace inclusion affects an employee's commitment and work-related performance (Meyer & Herscovitch, 2001; Bergman, 2006). Perceived workplace inclusion refers to the continuum to which an individual is accepted and taken as an insider by others at the workplace (Pelled et al., 1999). Perceived workplace inclusion fosters positive psychological outcomes, including pro social behaviors, job satisfaction, organizational citizenship behavior and organization-based self-esteem (Bortree & Waters, 2014; Mor Barak, 2017; Cottrill et al., 2014). When people are included, they fully contribute to the group's collective being, team or organization (Ferdman, 2017).

Workplace inclusion has become the focus of attention in recent years in scholarly and practitioner literature, especially for those who have to experience discrimination at the workplace due to specific reasons (Shore, Cleveland & Sanchez, 2017; Ferdman & Deane, 2014). Organizations are becoming more aware of inclusive environments' importance because of growing diverse work environments (Nishi & Rich, 2014).

2.1.8 Workplace Exclusion

Workplace exclusion negatively affects health psychologically and physically (Piedie, Gilrane, King, & Gray, 2013; Shore, Cleveland & Sanchez, 2017). Perceived workplace exclusion consists of various undesirable emotional states: loneliness, social anxiety, sadness, guilt, embarrassment and shame (Leary, Koch, & Hechenbleikner, 2001). Employees who are excluded are experience increased aggression and do not engage themselves in long term organizational interest (Twenge, Baumeister, Tice, & Stucke, 2001). Perceived workplace exclusion has negative consequences, some of which are threatened individuals' innate needs (Scott, Zagenczyk, Purvis & Cruz, 2014). Employees who are excluded by others are deprived of resources, i.e., social support and workplace exclusion is a type of incivil behavior (Ferris et al., 2017).

When a person is excluded by someone, he makes intentional attempts not to directly contact the perpetrator (Cheuk & Rosen, 1994). Employees who experience exclusion by their coworkers show reduced cognitive functioning with lesser motivation for prosocial behaviors (Baumeister & Dwall, 2005). The concept of workplace exclusion has been prevalent for years for maintaining social class, relationships and order among cultures (Scott, Zagenczyk, Purvis & Cruz, 2014). Workplace exclusion refers to the degree to which employees experience that they are being excluded or ignored by others at work ((Ferris, Brown, Berry, & Lian, 2008; Scott, Restubog & Zagenczk, 2013).

Employees becoming workplace victims may experience decreased satisfaction with work, poor psychological well-being, and declined performance. (Schneider, Hitlan, & Radhakrishnan, 2000; Baumeister, Twenge, & Nuss, 2002; Williams, 2001;

Hitlan, Clifton, & DeSoto, 2006).

There is limited research on antecedents of workplace exclusion and on factors that exacerbate the exclusion of few workers (Scott, Restubog & Zagenczyk, 2013). People develop norms that may help them and others survive and succeed among them. If someone violates those existing norms by going against them, it is taken a form of threat and has to experience workplace exclusion by others (Coleman, 1988). Workplace exclusion is somewhat similar to workplace uncivil behavior, but it is a comparatively less intense and less ferocious type of aggression, and it is not always aimed at harming others (Andersson & Pearson, 1999; Scott, Restubog & Zagenczyk, 2013).

2.1.9 Perceived Risk

Risk is referred to as the extent to which an individual perceives that an action or decision's potential outcome can be unfavorable (Yi et al., 2013). Perceived risk is associated with undesirable outcomes and uncertainty (Bauer, 1960). Unfavorable outcomes are characterized as potential losses and uncertainty regarding the dearth of information about future outcomes (Sharmaa, Hamarib, Kesharwanic & Tak, 2020).

The risk may be associated with amounts of money, one's performance, or it can be a social and psychological risk (Mitchell, 1999; Casidy & Wymer, 2016; Kaplan et al., 1974). Financial risk is characterized as the perceived possibility of facing monetary loss, and performance risk is characterized as the perceived undesirable performance (Casidy & Wymer, 2016). Psychological risk is characterized as the perceived possibility of experiencing unfavorable self-image (Kushwaha & Shankar, 2013; Casidy & Wymer, 2016; Sun, 2014) by engaging in any behavior or action. Casidy and Wymer (2016) characterized social risk as to the perceived possibility of experiencing social loss, i.e., social discomfiture.

Employees may judge about possible outcomes for engagement of voice, and this judgment is known as perceived risk (Morrison, 2011). The perceived risk enables an individual to assess or figure out the decision for engagement in voice behavior (Ashford et al., 1998). People are more likely to engage in voice behavior if they

believe that doing so will improve their image in the eyes of relevant others, and they are less likely to do so if it hurts their image (Morrison, 2011). According to Schema Theory, people use their previous experiences to form abstract schemata and then these schemata are used to appraise upcoming information (Lurigio & Carroll, 1985). It is suggested that employees who have positive associations developed to engage in voice behavior are more likely to repeat the voice behavior in the future. Whereas according to prospects theory, people engage in any behavior depending upon the perceived desirability of the outcome (Kahneman & Tversky, 1979). By associating the concept of prospects theory, an employee would be willing to engage in voice behavior if the perceived likelihood of engaging in the behavior results in a favorable outcome, i.e., perceived inclusion and not undesirable outcome, i.e., perceived exclusion.

2.1.10 Emotion Regulation

Employee actions are formed by the emotional states and how they manage the emotional states (Grant, 2013; Gross, 1998). Research illustrates a difference in employees' abilities for emotion regulation, and these abilities are of two types, i.e., assessing one's own emotions and assessing others' emotions (Mayer, Roberts & Barsade, 2008; Cote, 2005). Employees try to enhance one or more components of emotions, or they try to decrease or maintain them (Cote, 2005). Emotion regulation consists of a set of behaviors focused on selection and modification of feelings that derive from affect-eliciting situations and events (Madrid, 2020; Gross, 1998). Emotion regulation strategies are linked to experiencing enhanced well-being and improved task performance, and these strategies are an essential element of psychological functioning (Gross & Thompson, 2007). Depending on the theory of emotion regulation, it is said that people are motivated for improvement or deterioration of their emotions (Niven et al., 2009; Madrid, 2020). An individual may try to enhance pleasant feelings or try to eliminate unpleasant feelings if he is trying to improve the emotions. In contrast, in the case of deterioration, he may intensify negative feelings (Madrid, 2020). Employees may vary on their capabilities for emotion regulation as some of the employees may be capable of skills of

generation, intensification, continuation or even quashing their own feelings and others, whereas some may not be quite effective in the modification of their feelings and others (Mayer et al., 2008; Grant, 2013; Mayer et al., 2008). Emotion regulation skills may develop with time through specific experiences, or they are influenced by general mental abilities, which in turn influences one's capability of reasoning, learning and processing of complex information (Mayer et al., 2008; Izard et al., 2001; Grant, 2013; Cote & Miners, 2006).

2.2 Hypotheses Development

2.2.1 Relationship between Core Self Evaluation and Voice Behavior

As documented in the literature, voice behavior has many benefits for the organization, work team, and employees themselves (Edmondson, 2003; Nemeth, 1997; Weick & Sutcliffe, 2001; Mackenzie, Podsakoff, & Podsakoff, 2011). However, VanDyne and Lepine (1998) postulated about voice behavior that it may have detrimental consequences for those who engage in it because it can challenge the status quo and highlight inadequate work procedures and functions. Consequently, voice can lead to negative repercussions such as ridicule or even managers' feeling threatened by the voice (Tangiralla, Kamdar, Venkataramani & Parke, 2013). Thus employees need to evaluate the situation before speaking up as Tangirala et al. (2013) stated that employees might engage in voice to benefit the workplace or remain silent to avoid negative repercussions. Thus it seems necessary to explore what are the personality factors that are crucial behind voice prediction.

This specific issue is addressed by taking core self-evaluation as a precursor of voice behavior. According to Ayree, Walumbwa, Mondejar & Chu (2014), core self-evaluation is a construct that consists of higher order traits: self-esteem, self-efficacy, locus of control, and emotional stability. Core self-evaluation is considered a crucial phenomenon for years in organizational studies (Chang, Ferris, Johnson, Rosen & Tan, 2012). Core self-evaluation has been studied with a range of factors

like satisfaction and performance, career success, work engagement and low-stress levels (Judge & Bono, 2001; Judge, Locke, Durham, & Kluger, 1998; Judge & Hurst, 2007; Rich, LePine, & Crawford, 2010; Kammeyer-Mueller, Judge & Scott, 2009).

In another meta-analysis, core self-evaluation has also been linked to similar characteristics like justice perceptions, task performance, conscientiousness, autonomy and helping behavior (Chang et al., 2012). So core self-evaluation can build a relationship with various outcomes, researchers have recently given it more attention. According to Chang et al. (2012), core self-evaluation consists of three evaluation criteria: evaluation focus, scope and fundamentality. Evaluation focus is the degree to which one evaluates himself. Fundamentality refers to the extent to which traits are central to the concept of self, and scope shows that how broad or narrow is the self-esteem (Chang, Ferris, Johnson, Rosen & Tan, 2012).

People with high core self-evaluation are comparatively less intimidated by challenging situations (Judge & Hurst, 2007). They consider themselves more effective with higher self-confidence and perceive that they can control their environment more effectively. Aryee et (2014) posited that people with higher core self-evaluation have an internal urge or drive to control the external environment. Simultaneously, the person who may engage in voice behavior has a motivation to exert control (Tangirala & Ramunjam, 2008). People with higher core self-evaluation feel agency that fosters them to engage in voice behavior (Aryee et al., 2014). Aryee et al. (2014) suggested linking core self-evaluation to both dimensions of voice behavior.

Proactive behavior theory (Parker et al, 2010) postulates that people certain personality traits are more inclined to engage in proactive behavior i.e. voice behavior. Engaging in voice behavior is not safe as it challenges the status quo and resisted by senior management, colleagues and others (Liang, Frah, Farh, 2012) so such behaviors certain personality characteristics which are less afraid of engaging in behaviors which may have undesirable consequences for them. Thus core self-evaluation is said to have such characteristics such as self efficacy, self esteem, internal locus of control and a higher emotional stability.

Hypothesis 1: Core self-evaluation is positively related to promotive voice.

Hypothesis 2: Core self-evaluation is positively related to prohibitive voice.

2.2.2 Relationship between Supervisory Delegation and Voice Behavior

The importance of delegation has vastly increased in many current interest issues in the literature such as effective management of organizations, employee autonomy, work involvement, decentralization, empowerment and self-managed teams. Giving authority and responsibility to make decisions and assigning work tasks to subordinates by giving them more discretion is known as a delegation (Yukl, 1998). Yukl (1998) further adds up that delegation is a complex process and is considered an essential facet of effective management. Delegation may enhance workers' self-esteem and make them believe that they can perform work activities successfully and that their behavior makes a difference.

There are numerous gains of the delegation cited in literature by various researchers, which are enhanced quality and quick decisions, organizational commitment as well as an increased intrinsic motivation of workers (Yukl & Fu, 1999), better performance and job satisfaction of subordinates (Schriesheim, Neider & Scandura, 1998; Yukl & Fu, 1999), delegated employees feel more significant, and perceive higher status within the organization (Chen & Aryee, 2007; Gardner et al., 2004), provides a deeper level of understanding and expertise at employees level which may be lacking at senior level, (Ito & Person, 1986) because subordinates are usually more close to issues and customers thus increasing the efficiency of the organization.

The delegation reduces workload over seniors and boosts leadership skills among subordinates by making them self sufficient through which they can exercise their decision-making skills, provides self-direction and control, enhances self-efficacy and self-determination and the perception that they make an impact (Yukl & Fu, 1999; Thomas & Velthouse, 1990; Spreitzer, 1995).

When there is high delegation, employees are more comfortable taking the initiative and engaging in the voice, whereas employees less exhibit voice behavior when they perceive a lack of trust and lack of appreciation by their supervisors (Yukl & Fu, 99). Consequently, it would limit their effort to do more than expected of them and prefer to remain silent. When supervisors are open to subordinates, it creates a perception among employees that there are fewer power differences among them and motivates them to engage in voice behavior Edmondson's,2003; Milliken et al., 2003).

When subordinates perceive damaging feedback threat, they may less engage in voice behavior (Morrison & Milliken, 2000). Supervisor having the authority to give negative feedback is a threat to subordinates. Thus it may keep them away from engaging in voice (Ilgen, Fisher, & Taylor, 1979). Subordinates engage more in voice behavior when they perceive higher supervisory delegation, and they feel more comfortable in displaying voice behavior, whereas subordinates less exhibit voice behavior when they perceive that their supervisors do not trust them, lack appreciation and work-related delegation by supervisors (Xie, Chu, Zhang & Huang, 2014).

When supervisory delegation is high, it may create a more substantial relationship between subordinate and manager. Employees may feel the urge to engage in a voice that does not prove a threat to the manager. Voice may prove to be more facilitating for manager too by the provision of suggestions. Proactive behavior theory states that certain leadership specific factors may influence employees' tendency to engage in proactive behaviors (Parker et al, 2010) and employee voice behavior is a form of proactive behavior. Delegation of authority to employees is a form of leader related behaviors thus as per proactive motivation theory, it may foster employees tendency to engage in voice behavior. Thus supervisory delegation may enhance promotive and prohibitive voice.

Hypothesis 3: There is a positive relationship between supervisory delegation and promotive voice behavior.

Hypothesis 4: There is a positive relationship between supervisory delegation and prohibitive voice behavior.

2.2.3 Mediating Role of Felt Obligation for Constructive Change between Core Self Evaluation and Voice Behavior

Felt obligation for constructive change refers to the degree to which workers in organizations are committed to developing new work procedures and correcting the organizational problems (Liang et al., 2012). It is a form of internal motivation among individuals through which they reciprocate to the organization by exhibiting desired behavior to support the organization (Fuller, Marler & Hester, 2006).

Employees with strong felt obligation for constructive change are more likely to show change-oriented behavior as a favorable form of behavior (Liang et al., 2012). It is hypothesized that felt obligation for constructive change may mediate the relationship between core self-evaluation and voice behavior. Core self-evaluation is related to motivation and diligence at work (Eto & Watanbe, 2014; Judge & Kammeyer-Mueller, 2011). According to the notion of Judge, Erez and Bono (1998), when individuals believe in them with high self-confidence, they more believe their capabilities and such individuals are surer about their success. The stated relationship between core self-evaluation and success explains that individuals with high core self-evaluation will be more fostered to experience the felt obligation for constructive change. It may increase their belief that their engagement in the felt obligation for constructive change would positively form. They are more particular about bringing a change through them with felt obligation for constructive change. Such individuals' engagement in the felt obligation for constructive change will be more strongly related to their voice behavior engagement.

Core self-evaluation may directly impact the outcome (Judge et al., 1998) and influence the outcome through a positive self-view. Whereas, core self-evaluation may also indirectly influence outcomes through cognitions they develop about certain job characteristics and may influence outcomes by engaging in various actions like persistence on tasks (Chang, Ferris, Johnson, Rosen, Tan, 2012; Judge et al., 1998).

Taking this continuity of relationship, it can be attributed that core self-evaluation can directly influence and force a person to challenge the status quo by engaging in voice behavior. Core self-evaluation also tends to influence people engagement in voice behavior through the path of felt obligation for constructive change as core self-evaluation would influence a person cognition that he/she is obligated to pay back to the organization and accordingly engage them in voice behavior.

Many existing studies are on core self-evaluation but how it influences outcomes and the mediating mechanisms that may link core self-evaluation to outcomes require attention (Chang et al., 2012). Felt obligation for constructive change may foster an individual to think constructively regarding making suggestions and improvements through voice behavior. Proactive motivation theory states that certain personality characteristics influence an individual's tendency to engage in motivational states such as can, reason to do and energized to do (Parker, Bindl, & Strauss, 2010).

Thus core self-evaluation is a dispositional characteristic consisting of higher self-confidence and higher positive appraisal about oneself may foster an individual to engage in these motivational states in the form of felt obligation for constructive change for organization. The individual's felt obligation for constructive change then serve as a fuel between core self-evaluation and proactive behaviors i.e. promotive and prohibitive voice behavior. Thus felt obligation of constructive change may also serve as an underlying mechanism between dispositional characteristic i.e. CSE and outcomes in the form of proactive behavior i.e. both dimensions of voice behavior.

Hypothesis 5: There is a positive relationship between core self-evaluation and felt obligation for constructive change.

Hypothesis 6: Felt Obligation for constructive change mediates the relationship between core self-evaluation and promotive Voice.

Hypothesis 7: Felt obligation for constructive change mediates the relationship between core self-evaluation and prohibitive voice.

2.2.4 Felt Obligation for Constructive Change as a Mediator between Supervisory Delegation and Voice Behavior

Supervisors' delegation of power and authority invigorates and improves employees' decision-making skills and has many other positive outcomes such as improved task performance, innovative work behavior, job satisfaction, and organizational commitment (Chen et al., 2007). Kastle (2013) emphasized the importance of delegation that it has become one of the most effective techniques since an increasing number of organizations are adopting flat structures. Garwin (2013) discussed in one of his studies that one of the reasons for the success of organizations like Google and Facebook is the delegation of authority, making their employees more relaxed and enhancing their decision-making. Delegation by supervisors makes employees more empowered by making them more responsible for specific activities (Bass, 1990). When employees are delegated, they perceive themselves as accountable for their actions and feel that they are supposed to play a role in the organization's effective functioning. It is at this moment proposed that delegation is paving the way for felt obligation for constructive change. When employees perceive higher delegation by their supervisors, they feel responsible for completing the assigned task independently.

When employees are delegated, this makes them accountable towards their workplace and organizational functioning, thus fostering a higher felt obligation for constructive change, which forces them to improve the organizational processing and point out the organization's flaws. Employees consider themselves more important, trusted, and enhanced prestige when delegated (Chen & Aryee, 2007). Thus it can be proposed that higher delegation boosts employees' sense that they can create some difference in organizational functioning; thus, delegation increases the propensity of employees engaging in the felt obligation for constructive change.

Felt obligation for constructive change is the felt responsibility of employees to express their positive concerns to the organization (Fuller et al., 2006; Morrison &

Phelps, 1999). Felt obligation, as defined in the literature, is a belief of employees that they should help the organization for achieving its goals and improving its well-being (Eisenberger, Armeli, Rexwinkel, Lynch, & Rhoades, 2001). Thus it can be argued that when employees engage in the felt obligation for constructive change, it is an indication that there is an interaction between seniors and subordinates through delegation to develop felt obligation for constructive change. Thus supervisory delegation makes employees more confident that they are valued by the organization and should pay back to the organization by performing certain obligations. Thus delegated employees to feel that they are responsible for improving work conditions and work life.

People are more likely to engage in voice behavior if they feel responsible for workplace change. (Fuller et al., 2006; Parker & Collins, 2010). Felt obligation for constructive change is a psychological condition in which one considers that he is responsible for constructive changes and improvements in the work environment (Liang et al., 2012; Morrison & Phelps, 1999). Thus people high on felt obligation for constructive change engage in voice behavior considering they are caring for their workplace and showing concern by doing so (Liang et al., 2012).

Felt obligation for the organization is an individual's belief that he should be concerned about the organization's well-being and should help the organization achieve its goals. (Eisenberger, Armeli, Rexwinkel, Lynch, & Rhoades, 2001). Felt obligation fuels an individual to actively engage in the organization's betterment, thus motivating them to engage in voice behavior as voice behavior is speaking up for or raising the voice for unhealthy work practices (Liang, Farh & Farh, 2012).

Thus felt obligation for constructive change would help employees to raise their concerns about the organization. Felt obligation for constructive change makes people obligated towards the betterment of others (colleagues) and organization. So making it more straightforward, if individuals high on felt obligation for constructive change remain silent at wrong organizational practices, they may consider themselves as equally responsible for this. That's why it is proposed that felt obligation for constructive change would stimulate a responsibility among individuals for voice behavior. Felt obligation for constructive change was the most intensely

and uniquely related to promotive voice (Liang, Farh & 2012). Employees usually withhold and do not speak up if they feel speaking up is threatened (Morrison, 2011). Employees engage more in voice behavior when they have the self obligation, a kind of pressure over them for change. Employees experience a stronger sense of responsibility for voice when they have felt an obligation for constructive change (Liang, Farh & Farh, 2012). Felt obligation works as a motivating factor for workers' decision to engage in voice behavior (Ward, 2013). So it may be attributed that workers less engage in any kind of voice behavior when they have less obligation for change. Major work on self obligation for constructive change is done by Fuller et al. (2006). He also supports the notion that self obligation promotes voice behavior. The same was argued by other researchers like Withey and Cooper (1989) and Morrison and Phelps (1999) that feeling obligation for the organization is a major psychological factor behind workers' voice behavior. Employees who have more loyalty for the organization engage more in voice behavior (Hirschman, 1970). The employee would be more obliged to constructive change when they are loyal to their workplace. Employees who are more concerned about the group's interests and less prioritize their own interests are more likely to engage in voice behavior (Tangirala et al., 2013). Thus they have felt an obligation to improve organizational practices and procedures.

Felt obligation for constructive change is the felt responsibility of employees to express their positive concerns to the organization (Fuller et al., 2006; Morrison & Phelps, 1999). Felt obligation as defined in the literature as a belief of employees that they should help the organization achieve its goals and improve its well-being (Eisenberger, Armeli, Rexwinkel, Lynch, & Rhoades, 2001). Thus it is argued that felt obligation forces employees to engage in constructive opinions about the organization (Liang, Farh & Farh, 2012), i.e., voice behavior. Liang and Colleagues (2012) further stated in the same study that employees are more likely to engage in voice for a better workplace with higher felt obligation to change, and employees with lower felt obligation are less likely to participate in voice. Thus felt obligation for constructive change is a kind of responsibility towards the organization with a more profound concern for its betterment. Employees consider it a means for taking care of their workplace; according to Liang and Colleagues (2012),

it is a better exchange relationship with an organization. Liang and Colleagues (2013) stated that leaders should try to maximize subordinates' felt obligation for constructive change if they want to enhance employees' voice behavior. So engaging in voice should be a positive experience for employees. Felt obligation for constructive change is a form of internal commitment of employees towards an organization, which helps the organization transform in constructive ways (Fuller et al., 2006). Thus, when employees engage in voice, it is an indication that there is an interaction between seniors and subordinates through delegation to develop felt obligation for constructive change, which paved the way for voice behavior. Thus felt obligation for constructive change makes employees confident that the voice they would engage in would be useful and beneficial for the organization because trust and confidence inbuilt among employees are delivered through their supervisors by delegation.

Delegated employees feel that they are responsible for improving work conditions and work life. Felt obligation for constructive change would develop even in the context of the boss and subordinate relationship when the boss delegates work tasks to subordinates so that subordinates would feel obligated to achieve and help achieve specific organization goals as a whole.

Various researchers have considered felt obligation as an essential psychological antecedent for voice and influence them to correct problems and develop procedures (Morrison & Phelps, 1999; Fuller et al., 2006). There is little research examining the supervisory delegation's role on employees' voice behavior through felt obligation for constructive change. It is now argued that supervisory delegation may increase the employee engaging in voice behavior through felt obligation for constructive change. Hence, when employees are delegated, this makes them accountable towards their workplace and organizational functioning, thus fostering higher felt obligation for constructive change, which forces them to improve the organizational processing and point out the organization's flaws. This argumentation is consistent with the proactive behavior theory (Parker et al, 2010) that certain leadership specific factors influence employees' motivational states of can do, reason to do and energized to do. So when employees are delegated by their

supervisors as a leadership technique, it enhances employees motivational state of can do, reason to do and energized to do. These motivational states serve as a fuel for encouraging employees to engage in voice behavior.

Hypothesis 8: There is a positive relationship between supervisory delegation and felt obligation for constructive change.

Hypothesis 9: Felt obligation for constructive change leads to promotive voice.

Hypothesis 10: Felt obligation for constructive change leads to prohibitive voice.

Hypothesis 11: Felt obligation for constructive change mediates the relationship between supervisory delegation and promotive voice behavior.

Hypothesis 12: Felt obligation for constructive change mediates the relationship between supervisory delegation and prohibitive voice behavior.

2.2.5 Mediating Role of Emotion Regulation between Core Self Evaluation and Voice Behavior

Gross (1998) defines emotion regulation as the process by which one may influence his/her emotions. Emotion regulation is a phenomenon of self-regulation in which one makes an effort to manage both types of responses, which are behavioral and emotional (Trommsdorff & Rothbaum, 2008). Most of the studies on emotion regulation are conducted in a western context, so findings can not be generalized to other cultures (Trommsdorff & Rothbaum, 2008).

Emotion regulation is related to a person's goals (Trommsdorff & Rothbaum, 2008). Independent self celebrates and emphasizes promotion goals, autonomy, self-enhancement and explicit expression of emotions. On the other hand, it is an interdependent self that emphasizes fulfilling obligations to others, adjusting according to others and not expressing emotions publicly (Trommsdorff & Rothbaum, 2008). It is hereby assumed that people develop their emotions and regulates others at the workplace. People high on core self-evaluation openly express their emotions towards others while helping them because they are more confident about themselves. Emotion expression would be low for employees with lesser core self-evaluation, and such employees would not express their emotions over unpleasant tasks and procedures prevalent in the organization and consequently

would prefer not to engage in voice behavior.

There is a lack of research on emotion regulation in the context of voice behavior for employees. Emotion regulatory mechanism is an essential factor behind the decision to speak up, especially when it is for the organization's betterment and functioning. Similarly, as regulators of emotion, core self-evaluation has mainly been ignored as the impact of both is different for eliciting emotional responses. It can be argued from this discussion that people with high core self-evaluation have the potential of regulating their emotions successfully because they believed in themselves.

Previous literature suggests that employees with strong emotion regulation are characterized as more social by their peers and rated as better employees by their managers (Cote & Miners, 2016; Lopes et al., 2016). Emotion regulation is expected to influence the rate for which employees engage in voice behavior (Grant, 2013).

Studies on voice behavior opinionated that employees may withhold their voice because of possible outcomes associated with voice behavior (Morrison & Milliken, 2000; Ashford et al., 1998). Emotion regulation enables employees to feel secure for engagement in voice because it enables them to manage the fear associated with it. Strong emotion regulation enables employees to use reactive and proactive strategies for masking up their fear and for appraising their act of voice behavior (Grandey, 2000; Grant, 2013; Kish-Gephart et al., 2009). When employees have strong emotion regulation knowledge, they can attribute their unsuccessful attempts for engaging in voice behavior to external factors, thus not damaging their self-efficacy. In contrast, employees with poor knowledge of emotion regulation cannot cope with the threats associated with voice behavior (Gundlach, Martinko & Douglas, 2003). Thus strong emotion regulation is necessary for enhanced self-efficacy of employees for their tendency to engage in voice behavior more confidently and purposefully (Kish-Gephart et al., 2009). It is, therefore, suggested that emotion regulation is positively related to employees' voice behavior. Thus, engaging in voice behavior is motivated and behaviorally active because of the self-regulation of emotions (Zimmerman, 2001). Emotion regulation, as described by Yildiz (2016), is the mechanism of adaptation to challenges of one's

routine life and helps people preserve their well-being by reaching a higher-level goal. Core self-evaluation is a construct consisting of higher-order traits: self-esteem, self-efficacy, locus of control and emotional stability (Aree, Walumbwa, Mondejar & Chu, 2013). Thus these positive traits may help an individual to engage in proactive behavior, i.e., voice behavior. The processes and the outcomes of emotion regulation may depend upon varying conceptions of self and goals (Trommsdorff & Rothbaum, 2008), so emotion regulation, consequently, may mediate the relationship between core self-evaluation and voice behavior. The given argumentation is consistent with the theory of proactive motivation (Parker et al, 2010) that when an individual is engaged in the process of emotion regulation, he is evaluating himself that whether engaging in the voice behavior is required and whether he is capable of engaging in this challenging behavior and he would be looking for the cues required for motivational states that are can do, reason to do and energized to do. Thus emotion regulation serves as a underlying mechanism too between dispositional characteristic i.e. core self-evaluation and voice behavior.

Hypothesis 13: There is a positive relationship between core self-evaluation and emotion regulation.

Hypothesis 14: There is a positive relationship between emotion regulation and promotive voice.

Hypothesis 15: There is a positive relationship between emotion regulation and prohibitive voice.

Hypothesis 16: Emotion regulation mediates the relationship between core self-evaluation and promotive voice.

Hypothesis 17: Emotion regulation mediates the relationship between core self-evaluation and prohibitive voice.

2.2.6 Mediating Role of Emotion Regulation between Supervisory Delegation and Voice Behavior

Gross (2002) postulated about emotion regulation that it could be conscious and unconscious, and one can not claim about emotion regulation that it is inherently

good or bad. Soric et al. (2013) identified five types of emotion regulation: situation selection, situation modification, attention deployment, change of cognitions and modulation of responses that can be categorized as behavioral, experiential and physiological. Thus emotion regulation stemming from the supervisory delegation, which is a situation for employees; they evaluate it, develop cognitions and regulates emotion, consequently moving towards voice behavior.

One of the offsets of emotion regulation is behavioral in nature (Gross, 2002), and voice is a behavior as discussed by scholars. Emotion regulation can modify aspects associated with emotions like appraisal, subjective experience or behavior (Gross & Thompson, 2007).

Pekrun posited that emotions might alter depending upon antecedents as well as outcomes. Emotion regulation mostly enhances the positive emotional experience and dampens the negative emotional experience (Soric, Penezic & Buric, 2013). Tucker, Chmiel, Turner, Hershcovis and Stride (2008) concluded that organizational support and the role of supervisor support promote employees' voice behavior. Thus supervisory delegation makes employees more confident that they are valued by the organization and should pay back to the organization by performing certain obligations. Thus delegated employees may perceive that they are responsible for improving work conditions and work life.

Proactive behavior theory states that certain leadership specific behaviors may serve as triggering factor for fostering employees to engage in motivational states that are can do, reason to do and energized to do. These motivational states further enables employees to evaluate themselves and their situation for engaging in voice behavior. Thus supervisory delegation is a leadership specific characteristic that influence an individual's emotion regulation process. As a result that individual would evaluate his situation for engaging in proactive behavior as if they are encouraged by their immediate supervisor for certain behaviors, they would be more motivated to engage in those behaviors i.e. voice behavior.

Hypothesis 18: There is a positive relationship between supervisory delegation and emotion regulation.

Hypothesis 19: Emotion regulation mediates the relationship between supervisory delegation and promotive voice.

Hypothesis 20: Emotion regulation mediates the relationship between supervisory delegation and prohibitive voice.

2.2.7 Relationship between Voice Behavior and Managerial Hatred

When adverse workplace events occur, employees attempt to re-evaluate the present condition (Halperin et al., 2012). The situation's assessment leads the individual to an emotional reaction and sometimes accompanied by hatred reactions if they are victimized or belong to an out-group or targeted by the mentioned situation. These extreme emotional situations motivate the employees to revisit their status and behave according to the new circumstances. The situation's assessment moves employees to association seeking behavior, which may lead to undermining of previous associations. Research by Maoz and McCauley (2008) has shown that isolated emotions, irrespective of their positive or negative valences, affect attitude and behavior formation (e.g., Halperin, 2008, 2011). While much of the literature on emotions and voice behavior is silent, lacking references to hatred. This study focuses on the role of hatred as a consequence of voice behavior in the organization. In doing so, it is proposed to study the underlying mechanism due to which employees' voice behavior leads supervisors to experience hatred towards them. Literature is silent to explore the consequences of voice that what supervisor experience because of it. It's the manager to whom voice is raised. This study attempts to explore the hatred of managers as a consequence/outcome of voice behavior. It is widely accepted today that voice behavior has both favorable and unfavorable organizational implications. When employees engage in promotive voice behavior, intent of employee is taken constructive by senior management (Liang et al, 2012), because promotive voice behaviors aims to improve the current functioning of the organization. Employees concern is not interpreted negative in nature rather it is perceived positive for collective and improved workplace functioning. So it is assumed that in comparison to prohibitive voice behavior, the

relationship between promotive voice behavior and resultant managerial hatred would be negative. Employees would be evaluated positively by their immediate supervisors and the voice behaviors would be endorsed by them. However, prohibitive voice behavior is usually targeted at flaws of policies by supervisors and senior management, so it may be perceived as a negative form of expression. The emotional implications of voice behavior have only recently attracted some academic and research interest. For example, some scholars have presented negative emotions as consequences of voice behavior (Chiabaru et al., 2013).

Hochwarter and Treadway (2003) relied on evidence showing that those who scored high on negative affectivity were more vulnerable to adverse affective reactions, i.e., anxiety-provoking stimuli (McCrae & Costa, 1991). Voice behavior can create conflicts among employees and create friction in workgroups (LePine & Van Dyne, 1998; Milliken et al., 2003). Thus voice behavior has so many benefits for the organization, whereas it may also have harmful effects for those who engage in voice behavior. Vandewalle, Van Dyne, and Kostova (1995) proposed the same that voice can have negative repercussions for its raisers because of resistance by other organizational members. It may result in late work promotions and fewer pay raises (Siebert, Kraimer, & Crant, 2001). Voice behavior may damage voice raisers' image because they are viewed as problem creators (Milliken et al., 2003). Voice behavior can also result in low-performance evaluations for employees (Pinder & Harlos, 2001). Other studies pointed out that speaking up may result in high costs for employees (Seibert, Kraimer, & Crant, 2001). Hence, input from below may fall on deaf ears, and employees may be explicitly punished for challenging management's objectives and the current system of practices.

Weiss and Cropanzano (1996) affective events theory postulates that employees' emotional experiences influence employees' attitudes and behaviors. It is reasonable to assume that voice behavior evokes emotions such as endorsement, praise, resentment, contempt and anger. Given the contribution of understanding emotions (Salovey & Mayer, 1993; Mayer, Salovey & Caruso, 2004), it is surprising that the effects of voice behavior on the supervisory emotional responses have not yet been studied. Managers have a position because of hierarchy, which makes them

more competent than their subordinates (Morrison & Rothman, 2009). Thus promotive voice by employee may result in positive evaluation, praise and endorsement by the immediate management and may result in negative relationship between promotive voice and managerial hatred. Whereas, manager's status and position make them more avoidant from criticism raising because of the prohibitive voice behavior of employees. As discussed, voice can be promotive or prohibitive, i.e., improving existing work systems or challenging in nature. It is considered a criticism towards them, resulting in hatred towards employees. As Argyris and Schon (1978) claimed that managers have a strong need to refrain from feelings of incompetence and embarrassment. Prohibitive voice is considered as more person-focused thus more taken as blame by subordinate towards manager (Cheung & Liu, 2014).

Hypothesis 21: There is a negative relationship between promotive voice and managerial hatred.

Hypothesis 22: There is a positive relationship between prohibitive voice and managerial hatred.

2.2.8 Relationship between Voice Behavior and Perception of Workplace Inclusion

Human nature has a basic need for inclusion, recognition, and acceptance by social groups. Inclusion is defined as the degree to which employees consider themselves a valued person of the work group by undergoing such behavior from others that gratifies their belongingness need (Shore et al., 2011).

Perceived inclusion is a perception to which employees feel like a part of organizational processes, have access to information, perceives feelings of connectedness with others and consider themselves as influential and participative in the process of decision making (Barak, 2011). As it is a continuum, the higher the degree to which an employee perceives himself standing, the more the perception of workplace inclusion. The same has been proposed by Pelled et al. (1999) that inclusion refers to employees' perception of involvement in practices such as decision making and access to information by others. Thus higher the perception of inclusion by

employees, the better would be the organization's ability to succeed. This inclusive perception influences a person's belongingness and attachment feeling to the workplace, which is eventually useful for the organization.

Research examining how managers actually respond to voice has been limited. Promotive voice is innovative, and employees raise their constructive opinions and ideas through promotive voice. The promotive voice is future oriented while the prohibitive voice is both past and future oriented (Jian, Crystal & Farh, 2012). Promotive voice is innovative because it offers improvement in existing ways of doing things and helps make the organization a better workplace. It suggests an improvement in the effective functioning of the organization. Although promotive voice may bring temporary change, this change is usually good for the organization's long-term effective functioning. Burriss, Detert, and Romney (2013) posited that it all depends on the supervisors that how they perceive those who are engaging in voice. Suppose supervisors perceive employee suggestions as constructive and valuable. In that case, they may give a better evaluation, whereas when an employee's voice is considered as not constructive, they are likely to get a low evaluation by the supervisor.

Employees' investment in work roles is also related to the perception of inclusion (Carapinha, 2013). Thus when employees engage in voice behavior for the betterment of organizational processing and functioning, they are, in fact, investing in their own work roles in the short-run and organization in the long run. Extending Carapinha (2013) work means that employees who are more investing in their roles by engaging in promotive voice may be treated with workplace inclusion. As mentioned earlier, that promotive voice is considered excellent and improvement-oriented for long-term organization functioning. Proactive behavior theory (Parker et al, 2010) postulates that outcomes of proactive behavior can be favorable and unfavorable for those who are engaging in it. Thus employees when engaging in promotive voice behavior may enjoy connectedness in the form of inclusion by others and when engaging in prohibitive voice behavior may face unfavorable outcomes such that employees and seniors may not include them in their discussion, chit chat and gossip by withholding their views and information in their presence.

Hypothesis 23: There is a positive relationship between promotive voice and workplace inclusion.

Hypothesis 24: There is a negative relationship between prohibitive voice and workplace inclusion.

2.2.9 Relationship between Voice Behavior and Perception of Exclusion

Social exclusion is a broader term, narrowing it down; a person perceives the condition of being alone or lack of social contact by others (Blackhart et al., 2009). The social identity theory of Tajfel and Turner (1986) stated that individuals develop groups with whom they find themselves as most matching. As a result, in groups and out groups are developed. Thus employees who raise voice are interpreted based on the nature of their voice. If the voice is linear with those who are receiving it, employees are included in in-group, increasing their perception of workplace inclusion. If the voice is considered a challenge to others' positions and status quo, voice raisers are excluded from groups increasing their workplace exclusion perception. Prohibitive voice alarms management about possible harm to the organization. It may identify any issue or problem that may cause harm in the future (Liang, Farh & Farh, 2012). The prohibitive voice may identify a workplace problem that may influence current or future work processes at the organization. Thus it is easy to attribute that prohibitive voice tends to save the organization from potential future loss and prohibitive voice also indicate issues that arise because of specific management policies.

Evaluation of voice may depend upon the target to whom voice is being raised, i.e., supervisor (Burriss, Detert & Romney, 2013). As prohibitive voice tends to challenge the status quo (Liang, Farh & Farh, 2012), it is more about pointing out flaws in organizational practices. Extending the notion, the status and practices of an organization are more associated with senior management. They are involved in the development of organizational practices and policies. So whenever someone is engaged in prohibitive voice, senior management may take it as a more direct attack upon themselves. Thus prohibitive voice may cause conflicts with seniors

and others in the workplace because of its nature. Thus it can be proposed that prohibitive voicers may be excluded from their workgroups and teams. Because it may challenge the status quo present within the organization. When a member of the organization feels that he is being isolated, has less access to information, less connectedness with colleagues, and fewer opportunities to influence and participate in the decision-making process, the more he would perceive exclusion (Pelled et al., 1999). Plaut et al. (2011) have cited various researchers' work in his study and stated that perception of exclusion results in increased anxiety, decreased self-esteem, poor sense of belonging, impaired self-regulation, and decreased engagement in pro-social behaviors. Perceived exclusion can have toxic consequences for the health and well being of employees (Williams, Forgas, & Hippel, 2005).

All institutions, including family, and schools and workplaces can not deny the presence of social exclusion (Williams et al., 2005). Exclusionary behavior is passive in nature. Examples of exclusionary behavior include ignoring others and trying to give the silent treatment to others and harassing, making fun, teasing, or bullying are forms of exclusionary behavior (Williams, 2001).

Prohibitive voice targets and points out dysfunctional practices within an organization (Wei, 2015). It is proposed that employees who engage in prohibitive voice are disliked by senior management. Ashford et al. (2009) proposed that managers are more threatened when input and suggestions they receive from lower levels considering it as a challenge to their ways of doing things as in the case of prohibitive voice, it is directed towards workplace policies and practices. Seniors usually govern the majority of practices and tasks, and when an employee points out flaws in them, it is taken as a threat by senior management. In this situation, as Wei (2015) posits that employees have a strong need for protection from social disapproval and punishment. Exclusion is a form of disapproval and punishment for employees. According to proactive behavior theory (Parker et al, 2010), it is proposed that certain proactive behaviors are challenging in nature and threatens the status quo. Employee voice behavior is one of those threatening behaviors and challenges the status quo. It is against present working conditions and that's why it is always resisted by senior management, colleagues and subordinates. Thus

when an employee may engage in promotive voice behavior, that is about overall improved functioning of the organization, his suggestion might be appreciated and he may not have to face exclusionary behavior by others. But when he may engage in prohibitive voice behavior, that is about pointing out flaws in managers made policies, he may have to face exclusionary behaviors such as threats, silent treatment and being shunned by others at workplace. Thus, it is proposed that employees engaging in prohibitive voice may face more social exclusion threats from their colleagues and, more specifically, from seniors. Hence, it is hypothesized that;

Hypothesis 25: There is a negative relationship between promotive voice and perception of workplace exclusion.

Hypothesis 26: There is a positive relationship between prohibitive voice and perception of workplace exclusion.

2.2.10 Voice Climate as Moderator between Felt Obligation for Constructive Change and Voice Behavior

Group climate refers to people's collective values and opinions about specific behaviors and their decisions to engage in them (Kuenzi & Schminke, 2009). Similarly, Cialdini (2001) stated that while engaging in certain behaviors, employees depend on the group's shared beliefs to which they belong. The influence of group climate on the voice has also been studied (Morrison, Wheeler-Smith & Kamdar, 2011). The same has been argued by other researchers like Morrison et al. (2011) that a group's environment favoring constructive ideas encourages employees to speak up. Morrison et al. (2011) found that voice climate helps employees engage in voice behaviors. Morrison (2011) was the first to introduce the concept of voice climate with his colleagues in one of his empirical studies. The same has been proposed in the social learning theory of Bandura (1986) that it is actually the context that influences the effectiveness of specific modeled actions. As in this case context of the environment plays an essential role in the interplay of voice behavior and voice climate. Given social learning theory, social learning at the

group level stemming from voice climate interrelates with the employee's voice. Climate is defined as the shared perception about organizational practices, ways of doing things and procedures by employees that are widely shared by them (Schneider, 1990). Whereas voice climate is defined as shared perceptions of a workgroup to the extent to which they are encouraged to speak up and challenge the status quo (VanDyne & LePine, 1998). Employees at the workplace share various common beliefs about engaging in voice behavior, which is known as voice climate (Morrison et al., 2011). Morrison et al. (2014) further added up in one of their studies that voice climate helps organizational members to decide about engaging in voice behavior such that when voice climate is weak, employees perceive that better not to speak up because their voice may not be welcomed. When there is a weak voice climate, members of such a workplace would be hesitant to speak up. Liu and colleagues (2012) proposed that people stick to their response decisions when there is more alignment of personal and contextual cues. The same is postulated by contingency theories of leadership that factors like workplace culture and organizational structure play an important role in determining a leader's effectiveness for provoking specific responses by employees (Fiedler, 1964). As in this case, a voice climate is a form of organizational culture prevalent in the workplace, fostering employees' voice behavior. Parker et al (2010) in their proactive behavior theory stressed that certain contextual variables have the capacity to strengthen, weaken or antagonize the relationship between an individuals' motivational states i.e. can do, reason to do and energized to do and outcomes i.e. proactive voice behavior. Thus voice climate as a possible contextual variable specifically related to the work may alter the relationship between employees' felt obligation for constructive change and promotive and prohibitive voice behavior.

Hypothesis 27: Voice climate moderates the relationship between felt obligation for constructive change and promotive voice behavior such that the relationship is stronger when the voice climate is high.

Hypothesis 28: Voice climate moderates the relationship between felt obligation for constructive change and prohibitive voice behavior such that the relationship is stronger when the voice climate is high.

2.2.11 Voice Climate as Moderator between Emotion Regulation and Voice Behavior

Climate is defined as the shared perception about organizational practices, ways of doing things and procedures by employees that are widely shared by them (Schneider, 1990). Whereas voice climate is defined as shared perceptions of a workgroup to the extent to which they are encouraged to speak up and challenge the status quo (VanDyne & LePine, 1998). Employees at the workplace share various common beliefs about engaging in voice behavior, which is known as voice climate (Morrison et al., 2011). Morrison et al. (2014) further added up in one of their study that voice climate helps organizational members to decide speaking up such that when voice climate is weak, employees perceive that better not to speak up because their voice may not be welcomed. When there is a weak voice climate, members of such a workplace would be hesitant to speak up.

Liu and colleagues (2012) proposed that people stick to their response decisions when there is more alignment of personal and contextual cues. Thus, when there is more alignment between emotion regulation and voice climate, it would lead to more employee involvement in voice behavior. Something similar is postulated by contingency theories of leadership that factors like workplace culture and organizational structure play an important role in determining leaders' effectiveness for provoking specific responses by employees (Fiedler, 1964). Parker et al (2010) in their proactive behavior theory stressed that certain contextual variables have the capacity to influence the relationship between an individuals' motivational states i.e. can do, reason to do and energized to do and outcomes i.e. proactive voice behavior. Thus voice climate as a possible contextual variable specifically related to the work may strengthen the relationship between employees' emotion regulation and promotive and prohibitive voice behavior. As in this case, a voice climate is a form of organizational culture prevalent in the workplace, fostering employees' voice behavior.

Hypothesis 29: Voice climate moderates the relationship between emotion regulation and promotive voice behavior such that the relationship is stronger when the voice climate is high.

Hypothesis 30: Voice climate moderates the relationship between emotion regulation and prohibitive voice behavior such that the relationship is stronger when the voice climate is high.

2.2.12 Perceived Risk as a Moderator between Voice Behavior and its Outcomes

Existing literature on voice behavior emphasizes the manager's role in addressing the issues related to voice (Ashford, Sutcliffe & Christianson, 2009). Problem-oriented voice is considered a threat to the supervisor himself, so he tries to show some kind of behavior to counter the effect (Korsgaard, Roberson & Rymph, 1998). Simultaneously, employees who have better quality relationships with their supervisors perceive lesser risk while they engage in voice behavior (Van Dyne, Kamdar & Joireman, 2008).

Subordinates are the ones who have valuable information and innovative ideas for the success of the organization, whereas supervisors are the ones who have the power (Cheung, & Liu, 2014). Employees have to assess the environment if it is secure for them to engage in voice behavior (Cheung & Liu, 2014). Cheung and Liu (2014) further adds that employees would only engage in voice if it is safe to speak up and don't have harmful effects. Thus employees are always looking for a psychologically safe or unsafe working environment before speaking up (Detert & Burris, 2007). Promotive voice challenges the status quo, and others often perceive it as constructive in nature, and it contains fewer interpersonal risks (Wei & Colleagues, 2015); Liang et al., 2012). Whereas talking about prohibitive voice, it points out dysfunctional practices followed within the organization (Wei et al., 2015). Practices prevalent in the organization are usually implemented by top management or seniors. Thus prohibitive voice may hamper interpersonal relationships with seniors as it contains more interpersonal risks comparatively. The same has been proposed by researchers like Liang et al. (2012), Burris (2012), and Wei (2015). Thus summarizing these arguments, it is actually about the perceived risk associated with both types of voice. Employees may ponder and evaluate the risk associated with each type of voice before actually engaging in voice behavior.

Employees decide to engage in voice by determining the risk level by examining the managerial response to voice. Personal risk is an essential factor playing a role in the involvement of voice behavior (Milliken, Morrison, & Hewlin, 2003). Thus employees are more prone to engage in voice behavior when they can avoid the risk associated with raising voice (Burris, Detert & Chiaburu, 2008). When devoting their time and energy to voice raised, managers may not like the voice raiser because they are considered a threat to the manager's position, status, and prestige within the organization (Ashford et al., 2009). Managers may not only negatively evaluate voice raiser, but they may also be insecure towards voice raiser and may develop a negative perception about them or may punish them (Burris, Rockmann & Kimmons, 2017; Weiss & Morrison, 2018; Fast, Burris, & Bartel, 2014; Burris, Detert & Romney, 2013). Parker et al (2010) in their proactive motivation theory stated that engaging in proactive behavior may have certain positive and negative outcomes for those who engage in proactive behaviors. Proactive behaviors of employees are against present working conditions. It challenges the status quo and it is different from normal course of action that's why it is resisted by managers. Managers consequently may negatively evaluate the voice raiser and may develop negative perception about them and engage in hatred. Hatred is more possible to emerge if employee is engaging in prohibitive voice behavior as it is about pointing out flaws in policies and procedures developed by managers and similarly employees may have to face certain extreme and deep emotional reactions by managers in the form of hatred. It is assumed that if employees are able to evaluate the situation in terms of perceived risk for getting managerial hatred they are less likely to face managerial hatred by others. Similarly if perception for risk is low it is going to result in higher managerial hatred.

Hypothesis 31: Perceived risk moderates the relationship between promotive voice behavior and managerial hatred such that the negative relationship is strengthened when perceived risk is high.

Hypothesis 32: Perceived risk moderates the relationship between prohibitive voice behavior and managerial hatred such that the relationship is weakened when perceived risk is high.

Research examining the perceived risk as the moderator to the relationship of voice behavior and its outcomes is limited. The perceived risk may have a different impact on employees engaging in promotive and prohibitive voice because of the different nature of the two dimensions of voice. Employees engaging in promotive voice may perceive less risk, and those engaging in prohibitive risk may perceive more risk. Both dimensions, i.e., promotive and prohibitive, are challenging in nature although, promotive is more endorsed by others than prohibitive (Liang et al., 2012; Wei et al., 2015). It is said that others can identify constructive intent behind a promotive voice. Promotive voice is more likely to receive endorsement by others than prohibitive voice because of difficulty in identifying the good intention behind the prohibitive voice. As prohibitive voice raises concern for the stoppage of unhealthy practices at the workplace, it is sometimes considered a threat to top management (Cheung & Liu, 2014). Thus, according to the proactive behavior model theory, it depends upon the situation's judgment (Parker et al., 2010). Thus perceived risk is something that needs to be explored for this relationship. The same has been suggested by Liang and colleagues (2012) that employees evaluate the situation before speaking up to ensure the absence of risk associated and to ensure if their voice would be welcomed. As promotive and prohibitive voice are different in nature, promotive focuses on improving work practices and prohibitive being focused on raising concerns for practices that may harm the organization. Thus it is entirely reasonable to propose that perceived risk associated with the relationship between both types of voice and its outcomes may differ. Despite various studies on voice benefits, however, employees are not always comfortable in speaking up. There can be various reasons because of holding up their voice. Milkien and colleagues (2003) state that it can be a risk involved behind speaking up because voice tends to spoil the relationship with others because of its challenging nature. It all depends upon significant others, including seniors, subordinates and colleagues around voice raisers, that how they interpret the intent of voice raiser so voice raiser would also try to avoid this negative interpretation about him/her and would engage in a conscious attempt to develop a positive perception about him/her. Voice behavior is proactive, and there is a general perception associated with voice is of rocking the boat (Parker et al., 2010). Voice behavior as proactive

behavior challenges the current working system, consequently leading to discomfort for others (Parker et al., 2010). Given this generally negative relationship between voice and its repercussion for employees and positive outcomes, there has been no ample research that has examined this mechanism that why employees are reluctant to share their concerns and what perceptions they built because of engaging in voice. Parker et al (2010) in their proactive motivation theory stated that engaging in proactive behavior may have certain positive and negative outcomes for those who engage in proactive behaviors. It challenges the status quo and it is different from normal course of action that's why it is resisted by managers and others at workplace. Managers consequently may negatively evaluate the voice raiser and may develop negative perception about them and exclude from daily decision making process, workplace gossip and routine interaction. Workplace exclusion is more likely to occur if employee is engaging in prohibitive voice behavior as it is about pointing out flaws in policies and procedures developed by managers. Resultantly, employees may have to face certain exclusionary behaviors that is being shunned by others at workplace, getting silent treatment and being excluded. It is assumed that if employees are able to evaluate the situation in terms of perceived risk for getting the exclusion, they are less likely to face exclusion by others. Similarly if perception for risk is low it is going to result in higher exclusion by others at workplace.

Hypothesis 33: Perceived risk moderates the relationship between promotive voice behavior and workplace inclusion such that the relationship is stronger when perceived risk is high.

Hypothesis 34: Perceived risk moderates the relationship between prohibitive voice behavior and workplace inclusion such that the negative relationship is weakened when perceived risk is high.

Hypothesis 35: Perceived risk moderates the relationship between promotive voice behavior and workplace exclusion such that the negative relationship is strengthened when perceived risk is high.

Hypothesis 36: Perceived risk moderates the relationship between prohibitive voice behavior and workplace exclusion such that the relationship is weakened when perceived risk is high.

2.3 Hypothesized Model

2.3.1 Theoretical Framework

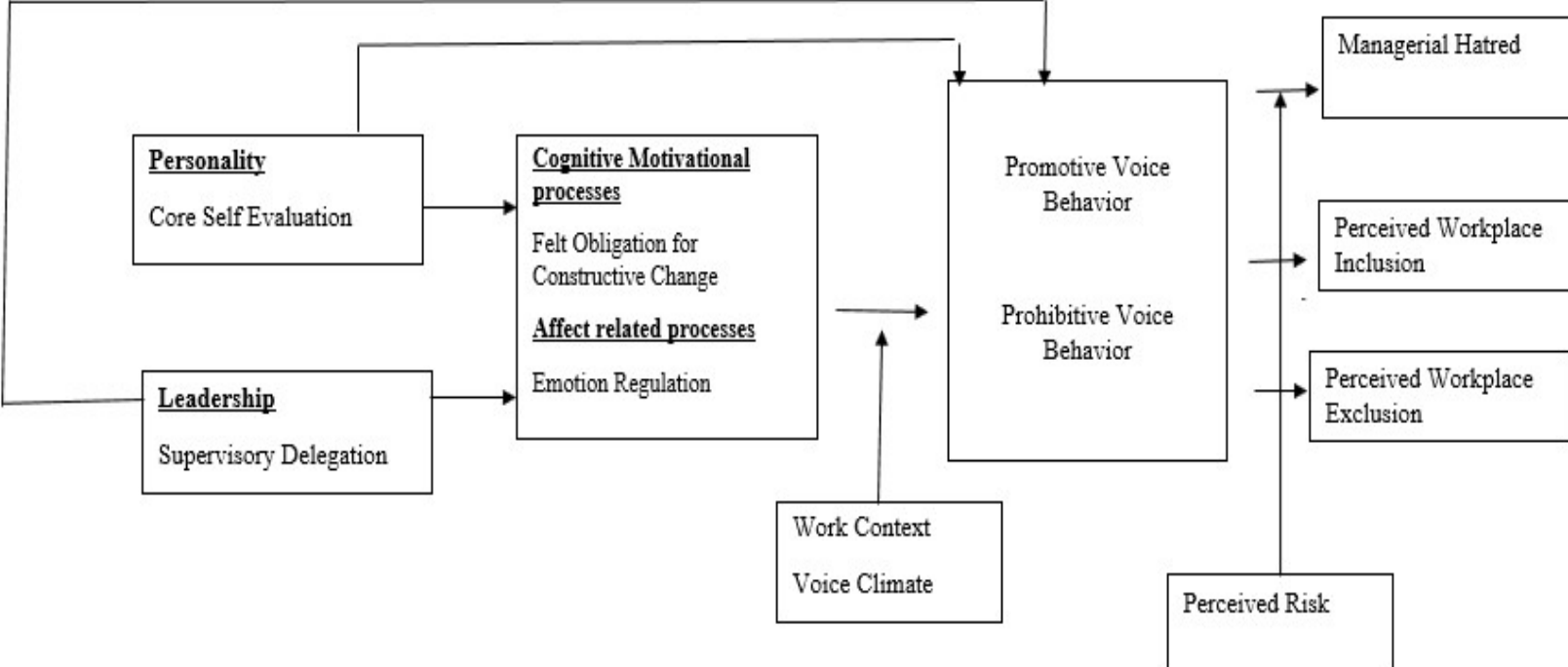

FIGURE 2.1: Research Model

Chapter 3

Research Methodology

This particular chapter identifies the methodology accustomed to explore the antecedents and outcomes of voice behavior. Role of felt obligation for constructive change and emotion regulation was tested as mediators between antecedents and voice behavior. Whereas the role of voice climate was explored as moderator between antecedents and voice behavior and the perceived risk was tested as a moderator between voice behavior and outcomes. It includes the research design, time horizon, unit of analysis, data collection procedure, sample, measures and details on demographics of the study.

3.1 Research Design

Research design is comprised of the details related to the nature of the study, type of the study, unit of analysis, study setting and time horizon. Research design is described as an arrangement of conditions that are used for the collection of data and analysis that are focused on the purpose of research with an economy in the procedure (Terre Blanche & Durrheim, 1999).

3.1.1 Type of the Study

The time horizon for this study was planned as a cross sectional study. Data has been collected in four phases. The study is causal in nature, assumed to determine

the antecedents of voice behavior and to explore the outcomes of voice behavior.

The present study is based on cause and effect relationship, and directional hypotheses are developed, and causal investigation can better serve the purpose of testing hypothesis. Along with causal, the co-relational investigation was also undertaken, but it was not used for the conclusion of results.

3.1.2 Study Setting

Quantitative data was collected using questionnaires in the natural work environment. Questionnaires were adapted from existing studies and likert scale was used to quantify the responses. All the questionnaires were measured on a five point likert scale where 1 measured the lowest intensity of any attitude or behavior and 5 measured highest intensity of any attitude or behavior. Participants in the current study were employees and their supervisors who were contacted on their workplace, so the current study was a field study.

3.1.3 Unit of Analysis

Unit of analysis used in the study was dyadic. Individuals and their head of departments working in IT organizations from public and private sector institutions are considered as the unit of analysis. Response from managers and their subordinates were taken depending each upon the nature of the scale.

3.1.4 Time Horizon

A time lag study was conducted to avoid the common method bias that typically occurs in cross-sectional applications. Data were collected in 4 Time Lags. Each time Lag consisted of a minimum of 3 weeks. The time lag is defined as the time between a stimulus and response or cause and effect. Several meta-analyses have shown that effects erode as the time lag between two measurements increases (e.g., Atkinson et al., 2000; Griffeth, Hom, & Gaertner, 2000; Hulin, Henry, & Noon, 1990;). Although no general conclusion can be readily drawn from existing

research, a rule of thumb has emerged, suggesting that effects decline as time lags become longer (Dormann & Griffin, 2015).

3.1.5 Data Collection Procedure

Data were collected in natural settings from full-time employees in four-time lags. Study one started as soon as permission granted by the supervisor, data about demographics, core self-evaluation and the supervisory delegation was collected in the first phase from employees. This first activity was complemented with a second term of data collection after three weeks to address the issue of common method variance (a problem with self-reported response). Data on felt obligation for constructive change and emotion regulation, (mediator variable) and voice climate (moderator variable) were collected in the second term. Response on voice behavior and perceived risk were collected in the third phase. Thus, the response on outcomes of voice behavior was collected in the last phase.

Response on voice behavior of employees and managerial hatred was collected from their head of departments and response on all other variables was collected from the employee himself.

To facilitate all phases of data collection and for the potential risk that employees may not like to share their names, scales were coded so that questionnaire could be filled back from same employees in next subsequent phases. Data were collected through questionnaires. It is a widely used tool for data collection (Sekaran, 2003). Details regarding scales along with authors are discussed in the instrument section

3.2 Population

Data on variables of interest were collected from telecommunications sector organizations. Printed questionnaires were used. The target sample was 700, and above, and unit of analysis were individuals and their supervisors. By following Sekaran (2003) for the known population, we can use the sample determination table. Krejcie and Morgan (1970) sample size table was consulted so defined sample size for the current study is 383 as Krejcie and Morgan (1970) reported if the

population size is 100,000 or around than at 95% confidence interval 384 is adequate for 5% margin of error. Thus a diverse sample of 415 respondents included different telecom sector employees.

Telecommunication sector was taken, and the sample was collected from their employees because the telecommunication sector is considered to be famous for intense competition with competitors; hence the importance of voice is of utmost importance. If telecom employees are allowed to give suggestions and encouraged to participate without fear of negative repercussions, they may feel more valuable, and it may lead to their obligation to pay back to their workplace.

3.3 Sampling

Convenience sampling was used. The procedure used for this technique is adopted from Sekaran (2002). Questionnaires were distributed in telecom organizations of various cities including Rawalpindi, Islamabad, Kohat, Peshawar and Attock. Human resource departments of concerned organizations were approached, and a list of their employees was taken to facilitate the sampling process. Number of distributed questionnaires were 715 at Time 1. Out of which 606 were returned with a percentage of 84% response rate. At time 2, the same 606 respondents were contacted again for their response on given scales and at this time, 553 questionnaires were returned with a response rate of 77 percent. The same 553 respondents were contacted again for getting their response for questionnaires distributed at Time 3.

A total of 452 questionnaires were returned with a percentage of 63 percent. These 452 respondents were contacted for Time 4 and a total of 429 questionnaires were collected back with a response rate of 60 percent. 14 questionnaires were not used because of missing values thus ended up the data collection over total of 415 questionnaires. Thus total organizations from which data was collected were 80. Number of subordinates were 415 and number of their immediate supervisors were 82. Almost all of supervisors were supervising not more than five subordinates.

So it was easy for every supervisor to rate his subordinate behavior on voice. Similarly, since there was close interaction between supervisor and subordinates so employees could easily rate their response on all measures.

Convenience sampling procedure is recommended in this case since the policy is to be formulated for the telecommunications sector as a whole. This implies that the most representative information has to be obtained that can be generalized to the whole telecommunication sector. This is best accomplished through this design.

3.4 Measurements

Responses were obtained by using a 5-point Likert-type scale with anchors 1 = strongly disagree, 2 = disagree, 3 = neither agree nor disagree, 4 = agree, and 5 = strongly agree. The scale used for control variables is as fellow. For Gender (1 for male and 2 for female), for age (1 = 25-30, 2 = 31-35, 3 = 36-40, 4 = 41-50 and 5 = more than 50), for education (1 = bachelors, 2 = MS, 3 = Masters), for experience (1 = less than year, 2 = 1-3, 3 = 4-7, 4 = 8-10 and 5 = more than 10 years), for marital status (1=single, 2=married).

3.4.1 Core Self-Evaluations

Core Self Evaluation was measured using a 12 item scale of Judge Erez, Bono, and Thoresen's (2003). A sample item from this scale is "When I try, I generally succeed." It was measured on a five-point Likert scale ranging from strongly disagree to strongly agree.

3.4.2 Supervisory Delegation

The supervisory delegation was measured by the 6-item scale developed by Yukl, Wall, and Lepsinger (1990). Sample Items include "my boss delegates to me the authority to make important decisions and implement them without his or her prior approval". It was measured on a five-point Likert scale ranging from strongly disagree to strongly agree.

3.4.3 Felt Obligation for Constructive Change

Felt Obligation for Constructive Change was measured through 5 items scale developed by Eisenberger, Armeli, Rexwinkel, Lynch & Rhoades's (2001). This scale was measured on a five-point Likert scale ranging from strongly disagree to strongly agree. Sample item includes "I owe it to the organization to do whatever I can to come up with ideas/solutions to achieve its goals" and "I have an obligation to the organization to voice out my own opinions."

3.4.4 Emotion Regulation

A 10 item scale of Gross and Jones (2003) was used to measure emotion regulation. Sample items include "When I am feeling negative emotions, I make sure not to express them". It was measured on a five-point Likert scale ranging from strongly disagree to strongly agree.

3.4.5 Voice Behavior

Voice behavior was measured through 10 items scale developed by Liang, Farh & Farh (2012). This scale was measured on a five-point Likert scale ranging from never to constantly. Sample item of promotive voice includes "Raise suggestions to improve the unit's working procedure" and prohibitive voice as "Advise other colleagues against undesirable behaviors that would hamper job performance."

3.4.6 Managerial Hatred

Hatred was measured by a 7 Item scale by Halperin, Canetti & Kimhi (2012). Sample items include "To what degree do you estimate that some of the actions of your employee are a result of a "bad" internal character". It has been developed for a different context. It would be adapted and validated for the present study. It was measured on a five-point Likert scale ranging from strongly disagree to strongly agree.

3.4.7 Perceived Workplace Inclusion

Perceived Workplace Inclusion was measured by using the scale developed by Mor Barak & Cherin, (1998) of ten items. This scale measures the extent to which employees consider themselves as part of critical organizational processes such as access to information, connectedness to co-workers, workgroup engagement. This scale was measured on a five-point Likert scale ranging from strongly disagree to strongly agree. Sample items include “My judgment is respected by members of the workgroup” and “People in workgroup listen to what I say”.

3.4.8 Perceived Workplace Exclusion

Hilton and Noel (2009), 14 item scale was used to measure the perceived exclusion from coworkers and supervisors. This scale has 14 items. Responses were ranked on a five-point scale ranging from never to most of the time. Items included are such as “Co-workers giving you the impression that they enjoy your company,” “Feeling accepted by other employees at your organization” and “Felt as if you were being ostracized by supervisors”.

3.4.9 Perceived Voice Climate

A six-item scale of Van Dyne and LePine (1998) was used to measure voice climate. Sample items include “The employees in my workgroup are encouraged to develop and make recommendations concerning issues that affect the group. It was measured on a five-point Likert scale ranging from strongly disagree to strongly agree.

3.4.10 Perceived Risk

Scale for perceived risk was validated according to the suggestion of Wei et al. (2015). It was measured on a five-point Likert scale ranging from strongly disagree to strongly agree. Sample item includes “If I engage in voice, my boss would think

that I do not respect him/her” and if I engage in voice, He/she will create troubles on my job in the future”.

3.5 Data Collection and Management

Data were collected from telecom sector from various cities across Pakistan. In order to address the social desirability basis, a specific procedure was followed. Telecom organizations were approached personally and explained the subject of the thesis. Human resource department was briefed about the purpose of the study and data collection. Respondents and human resource departments were assured about the confidentiality of their identity.

During initial interaction, a cover letter was offered to respondents clearly indicating that their participation is voluntary, and the author is not interested personally in their identities. Questionnaires were mentioned with specific instructions stating that: Respondents are requested to take several minutes to respond to the statements given on the enclosed questionnaire. There is no correct or incorrect answer to any statement, and your honest opinion is highly appreciated. Moreover, participating in the survey is entirely voluntary”. The briefing regarding study helped respondents to understand the purpose and the researcher was allowed to get the data collection from respective organizations.

Personal contacts were also used to get access to many telecom organizations. Consequently, the researcher collected data from various cities of Pakistan in the natural job setting. Respondents were contacted from various departments of companies and were requested to complete the survey at various points with a lag of 3 weeks between Time 1, Time 2, Time 3 and Time 4.

To match the questionnaires from various time lags, and to ensure the anonymity of respondents, they were asked to give the last four digits of their cell numbers. Purpose of this activity was again briefed that for the completion of follow up a questionnaire from the same respondent, these four digits would identify after an individual a given time period. Whereas to get the response of their immediate head, employees questionnaire taken from the various department were coded with

departments initials. Collection of data from employees, their immediate supervisors and taking at various time lags insured the absence of social desirability bias (Sullman & Taylor, 2010; Davis, Thake & Vilhena, 2010).

3.5.1 Time Lag 1- T1

In Time lag 1, Demographics, core self-evaluation and supervisory delegation were measured at Time 1. Core self-evaluation and supervisory delegation are the independent variables.

3.5.2 Time Lag 2-T2

Felt obligation for constructive change, emotion regulation and voice climate were measured at Time 2. Felt obligation for constructive change and emotion regulation are proposed as the effect of core self-evaluation and supervisory delegation.

3.5.3 Time Lag 3-T3

Voice behavior and perceived risk were measured at Time 3. Voice Behavior is the proposed effect of the mechanism through felt obligation for constructive change and emotion regulation by core self-evaluation and supervisory delegation. Perceived risk is the proposed moderator.

3.5.4 Time Lag 4-T4

Perceived workplace inclusion and perceived workplace exclusion and managerial hatred were measured at Time 4, which is proposed as the effect of voice behavior.

3.6 Pilot Study

A pilot study was conducted on matched dyads supervisor-employee of 120. Pilot testing is suggested to ensure that structure of the scales are valid and contains face validity (Acquadro, Conway, Hareendran & Aaronson, 2008).

3.6.1 Pilot Testing Reliabilities

Results of reliability analysis revealed that the respondents well comprehended all questionnaires. Reliability of each scale extracted through pilot testing has been given in **Table 3.1** along with the number of items for each scale.

TABLE 3.1: Alpha Reliabilities of Scales

Variables	Items	Reliabilities
Core Self Evaluation	12	0.88
Supervisory Delegation	6	0.79
Felt Obligation for Constructive Change	5	0.72
Emotion Regulation	10	0.79
Promotive Voice	5	0.70
Prohibitive Voice	5	0.78
Workplace Inclusion	10	0.84
Managerial Hatred	7	0.87
Perceived Risk	8	0.91
Voice Climate	6	0.87
Workplace Exclusion	14	0.90

3.6.2 Validity of the Instrument

Pilot testing was conducted to make sure that all instruments are valid according to Pakistani culture as well as the Asian context. So initially 120 questionnaires were distributed. The purpose behind pilot testing was to detect any flaws and imperfections in all distributed questionnaires and also to check the overall feasibility analysis of research instruments. Pilot testing also helped to clarify ambiguities regarding tools being used, techniques being implied, research topic, and research questions. Medium for scales was the English language as it is easily and broadly understood and used by employees of telecommunication companies. Questionnaires were distributed to employees through self-administered methods.

Human Resource Office and heads of departments were contacted to get the attitude of employees and their immediate heads. Statements of questionnaires were modified a little to fit Pakistani context, so all of the scales were adapted. So it was necessary to restructure the statements of existing scales. Similarly, an asterisk (*) was placed to reverse questions for accurate data entry. The scale of hatred was restructured to get the response of the supervisor on items.

3.7 Main Study

The author performed to follow up full study results after pilot testing to get reliability estimates and to get validation of hypothesis.

3.8 Sample Characteristics

Identification of the characteristics of respondents, including employees and their immediate boss is essential. The characteristics are discussed as follows in tables.

The sample of respondents consists of employees of telecommunication companies. Their demographic characteristics are given below. A total of 45% of the respondents were male, 55 percent were female. 57% were married, 42 percent were single. Majority of the respondents (34%) were between the ages of 25-30. The sample was well educated; 33% of the respondents had bachelor's degrees, while 42% were MS/MPhil degree holders. 19% had 4 to 7 years, and 15 percent had 7 -10 years of experience. Details of covariates are given in the following tables. Furthermore, ANOVA was performed to know the significant influence of demographics over studied variables.

3.8.1 Gender of Respondents

Table 3.2 indicates that among respondents, 45% were male, and 54% were female who responded about their attitudes in organizations.

TABLE 3.2: Gender

Gender	Frequency	Valid Percent	Cumulative Percent
Male	188	45	45
Female	227	54	100
Total	415	100	

3.8.2 Marital Status

Marital status of respondents shows how many of them were married and how many were unmarried. Maximum respondents that is 57% marked themselves as married.

TABLE 3.3: Marital Status

Marital Status	Frequency	Valid Percent	Cumulative Percent
Single	177	42	42
Married	238	57	100
Total	415	100	

3.8.3 Age

Table: 3.4 shown below, indicates different age groups. It indicates that 17% of respondents' age was between 25-30 years, 20% of participants' age between 31-35 years and so on.

TABLE 3.4: Age

Age	Frequency	Valid Percent	Cumulative Percent
25-30	140	33.7	33.7
31-35	143	34.5	68.2
36-40	68	16.4	84.6
41-50	49	11.8	96.4
More than 50	15	3.6	100
Total	415	100	

3.8.4 Education

Information regarding qualification was also gathered. The table indicates the level of respondents' qualification. 33% of participants were bachelor's degree holder, 42% of respondents were MS/M. Phil and rest were Master's degree holders.

TABLE 3.5: Education

Education	Frequency	Valid Percent	Cumulative Percent
Bachelors	140	33	33
MS/Mphil	175	42	75
Masters	100	24	100
Total	415	100	

3.8.5 Experience

The data concerning the experience of employees were gathered using a categorical scale. **Table: 3.6**, indicates that 10% of respondents had less than one year, 16% of participants had 1-3 years of experience, and 17% of respondents had 4-7 years of experience and so on.

TABLE 3.6: Experience

Tenure	Frequency	Valid Percent	Cumulative Percent
Less than 1 year	42	10.1	10.1
1-3 years	66	15.9	26
4-7 years	72	17.3	43.4
7-10 years	146	35.2	78.6
More than 10 years	89	21.4	100
Total	415	100	

3.9 Measurement Model

Confirmatory factor analysis was performed on the full measurement model for the thesis to obtain the fit statistics, i.e. CMIN/df, IFI, RMSEA, CFI and TLI.

Results are shown in **Table: 3.7**. The table shows that items of all factors such as core self-evaluation, supervisory delegation, felt obligation for constructive change, emotion regulation, promotive voice, prohibitive voice, hatred, perceived inclusion, perceived exclusion, voice climate and perceived risk were significantly loaded on their respective factor. Standardized loading magnitude of respective items was reasonable as well. Most of the estimates of the item were above .70 and items were significantly indicating their respective underlying construct with $p < .001$. The obtained results of the confirmatory factor analysis showed the fit statistics. Fit indices of the 11-factor model were CMIN/df= 1.138, CFI=.96, GFI=.82, RMSEA=.018, TLI =.95 and IFI=.95. Results of CFI were as per standards proposed by Hu and Bentler (1999). Results in table 3.7 shown proved an excellent fit for 11 factors proposed model. Convergent validity was also quite evident through the findings. As far as loadings are concerned, they ranged between .65 to .95, which are indicative of convergent validity. The findings indicate appropriate fit indices, thus indicating that path analysis can be performed. Whereas discriminant validity was evaluated by comparing the proposed 11-factor model with other comparative alternate models. Alternate 10 factor model and 9 factor models were also tested. Especially, scores of IFI, TLI, GFI AND GFI on 10-factor model and 9 factor model were poor as compared to 11-factor model. Results of comparative models were lower than the proposed 11-factor model. Fit indices of the 10-factor model were CMIN/df= 1.20, CFI=.93, RMSEA=.02, TLI =.93, GFI=.80 and IFI=.93. Fit indices of the 9-factor model were CMIN/df= 1.43, CFI=.86, RMSEA=.03, TLI =.86, GFI=.74 and IFI=.86..

TABLE 3.7: Measurement Model

Models	CMIN/DF	RMSEA	IFI	TLI	CFI	GFI
Threshold Values	<3	.05-0.1	>0.9	>0.9	>.95	>.95
Original 11 factor model	1.130	0.018	0.950	0.950	0.960	0.820
Alternate 10 factor model	1.200	0.020	0.930	0.930	0.930	0.800
Alternate 9 factor model	1.430	0.030	0.860	0.860	0.860	0.740

In order to further confirm the discriminant and convergent validity of study variables, average variance extracted and maximum shared variance were tested. Average variance extracted (AVE) was equal to and greater than the cutoff criterion of 0.5 for all the study variables, thus establishing convergent validity for the study variables. The value of maximum shared variance was less than the value of average variance extracted for all the variables, thus establishing discriminant validity for the all the study variables. The results of average variance extracted and maximum shared variance are shown in table.

TABLE 3.8: Average Variance Extracted and Maximum Shared Variance

Variables	AVE	MSV
Core self-evaluation	0.51	0.21
Supervisory delegation	0.52	0.22
FOCC	0.50	0.20
Emotion regulation	0.50	0.20
Promotive Voice	0.53	0.23
Prohibitive Voice	0.52	0.22
Managerial hatred	0.51	0.21
Perceived inclusion	0.55	0.26
Perceived exclusion	0.54	0.25
Voice climate	0.56	0.26
Perceived risk	0.52	0.22

3.10 Covariates

After a review of the relevant literature, few variables were decided to check their influence over variables of interest. e.g., age, gender, marital status, qualification, designation and tenure. Previous literature showed these variables might be having a specific influence upon variables of interest. As it can be assumed that gender can be a strong predictor of voice (Detert & Burris, 2007). One's educational level can also influence people to engage in voice behavior. As according to Frese, Teng, & Wijnen (1999), higher the level of education, more the person would have ideas to be shared. Similarly, one's designation and tenure in the organization may also influence their propensity to influence voice behavior and its outcomes. One's tenure can be an antecedent of voice (Liang, Farh, & Farh, 2012; Tangirala

& Ramanujam, 2008). Longer the tenure, the more a person feels secure to engage in voice. According to literature, people at higher positions feel more obligated to engage in voice behavior (Liang, Farh & Farh, 2012; Fuller et al., 2006). So is the role of marital status as ironically said, if men are married, there are chances that they might have learned not to engage in voice behavior. So covariates were checked through ANOVA to know their influence before taking the decision of controlling.

There were insignificant differences in FOCC across gender ($F = 3.48, P > .05$), insignificant difference across marital status ($F = 2.77, P > .05$), insignificant difference across age ($F = .79, P > .05$), insignificant difference across qualification ($F = 1.07, P > .05$), insignificant difference across time spent with tenure ($F = .08, P > .05$). There were insignificant differences in ER across gender ($F = .002, P > .05$), insignificant difference across marital status ($F = 2.77, P > .05$), insignificant difference across age ($F = 1.3, P > .05$), insignificant difference across qualification ($F = .48, P > .05$), insignificant difference across time spent with tenure ($F = .30, P > .05$).

There were insignificant differences in Promotive voice across gender ($F = .25, P > .05$), insignificant difference across marital status ($F = .44, P > .05$), insignificant difference across age ($F = 1.3, P > .05$), insignificant difference across qualification ($F = .13, P > .05$), insignificant difference across time spent with tenure ($F = .57, P > .05$). There were insignificant differences in Prohibitive voice across gender ($F = .000, P > .05$), insignificant difference across marital status ($F = .24, P > .05$), insignificant difference across age ($F = 1.3, P > .05$), insignificant difference across qualification ($F = 1.5, P > .05$), insignificant difference across time spent with tenure ($F = .93, P > .05$).

There were insignificant differences in perceived hatred across gender ($F = .01, P > .05$), insignificant difference across marital status ($F = .105, P > .05$), insignificant difference across age ($F = 2.3, P > .05$), insignificant difference across qualification ($F = .09, P > .05$), insignificant difference across time spent with tenure ($F = 52, P < .05$). There were insignificant differences in perceived workplace inclusion across gender ($F = .12, P > .05$), insignificant difference across marital status ($F = 1.8, P > .05$), insignificant difference across age ($F = .56, P > .05$), insignificant

difference across qualification ($F = 1.7, P > .05$), insignificant difference across time spent with tenure ($F = 13, P > .05$).

There were insignificant differences in perceived workplace exclusion across gender ($F = 1.75, P > .05$), insignificant difference across marital status ($F = .783, P > .05$), insignificant difference across age ($F = 1.59, P > .05$), insignificant difference across qualification ($F = 1.5, P > .05$), insignificant difference across time spent with tenure ($F = .33, P > .05$).

3.11 Reliability Analysis

Reliability analysis of a scale shows the ability of a scale to produce the same results consistently when tested across several times. The value of Chronbach Coefficient Alpha may range from 0 to 1. An Alpha value which is equal to or more than .70 is considered as more reliable (Nunnally & Bernstein 1994) as compared to the Alpha value, which is less than 0.70. **Table: 3.8** shows the Chronbach Coefficient values of the scales used in the study, all of which are more than .70 showing that all scales are reliable. As value of S.D=.76, CSE=.87, FOCC=.70, ER=.80, Promotive Voice=.70, Prohibitive Voice=.75, VC=.87, PWIN=.83, PWEX=.89, Perceived Hatred=.87, and P.R=.91.

TABLE 3.9: Reliability of Variables

Variable	Reliability	No of Items
Core Self Evaluation	0.87	12
Supervisory Delegation	0.76	6
Felt Obligation for Constructive Change	0.70	5
Emotion Regulation	0.80	10
Promotive Voice	0.70	5
Prohibitive Voice	0.75	5
Workplace Inclusion	0.83	10
Managerial Hatred	0.87	7
Perceived Risk	0.91	8
Voice Climate	0.87	6
Workplace Exclusion	0.80	14

Chapter 4

Results and Findings

Quantitative analysis techniques including descriptive analysis, analysis of variance, correlation and regression analysis were used to test the hypothesis and respond to research questions. Quantitative analysis is used for hypothesis testing or when researcher has to find out the impact of one variable over the other and when one has to find out the relationship between various variables (Jansen, 2020). The techniques that are used to infer the results are an attempt to respond to the research questions (Durcevic, 2020). So analysis of variance, descriptive statistics, correlation and regression analysis are used to respond to study research questions because researcher's most of the research questions are based on finding the relationship between variables, hypothesis testing and assessing the impact of antecedents and outcomes of variables.

4.1 Descriptive Analysis

The descriptive statistics are used to know the uni-variate summary statistics for different variables and calculations of standardized values. The descriptive technique is used to tell details of the study like sample size, the standard deviation of study variables and minimum and maximum mean values. These mentioned values have been calculated and given in table 4.1. Where the first column is showing the variables name, and consequent columns show the details regarding sample size, standard deviation, minimum and maximum value.

Table: 4.1, shows that the sample size was 415 for this study. The mean value of any variable shows the essence of responses. The mean value of core self-evaluation was 3.22, which shows that respondents were agreed that they have CSE. The mean values of the supervisory delegation were 3.29, which shows that respondents were experiencing delegation by their supervisor. Mean value of felt obligation for constructive change was 3.36, which shows that they were experiencing obligation towards the organization. The mean value of emotion regulation was 3.29, that shows respondents knew the essence of it. Mean value of voice climate was 3.32 that they understood the presence of specific variable at the workplace. Mean value of promotive voice and prohibitive voice was 3.45, 3.29 respectively that shows that supervisor knew the occurrence of the specific type of behavior. Mean value of hatred was 2.87 that showed that respondents agreed that they experienced hatred against their employees. Whereas the mean value of workplace inclusion and workplace exclusion was 3.10, 3.09, respectively, that confirmed that respondents experienced the presence of specific perception at the workplace.

TABLE 4.1: Descriptive Statistics

Variables	N	Min	Max	Mean	S.D
Gender	415	1	2	1.54	0.49
Marital Status	415	1	2	1.57	0.49
Age	415	1	5	2.17	1.12
Qualification	415	1	3	1.90	0.75
Tenure	415	1	5	3.40	1.20
Core Self Evaluation	415	1	5	3.22	0.71
Supervisory Delegation	415	1	5	3.29	0.77
FOCC	415	1	5	3.36	0.69
Emotion Regulation	415	1	5	3.21	0.67
Promotive Voice	415	1	5	3.45	0.72
Prohibitive Voice	415	1	5	3.29	0.81
Voice Climate	415	1	5	3.32	0.90
Hatred	415	1	5	2.87	0.86
Workplace Inclusion	415	1	5	3.10	0.80
Workplace Exclusion	415	1	5	3.09	0.83
Perceived Risk	415	1	5	3.15	0.95

TABLE 4.2: Correlation Analyses

Sr. No	Variables	1	2	3	4	5	6	7	8	9	10	11
1	Core Self Evaluation	1										
2	Supervisory Delegation	.31**	1									
3	Felt Obligation	.37**	.34**	1								
4	Emotion Regulation	.35**	.42**	.30**	1							
5	Voice Climate	.27**	.28**	.31**	.27**	1						
6	Promotive Voice	.38**	.42**	.38**	.36**	.24**	1					
7	Prohibitive Voice	.25**	.36**	.16**	.22**	.14**	.38**	1				
8	Hatred	-0.02	-0.08	-.16**	-.13**	-0.07	-.26**	.14**	1			
9	Workplace Inclusion	.13**	.09*	.18**	.10*	0.01	.34**	0.08	-.38**	1		
10	Workplace Exclusion	0.03	.13**	-0.04	0.04	-0.01	0.03	.47**	.58**	-.31**	1	
11	Perceived Risk	-0.05	.14**	.11*	.15**	0.04	0.09	-0.08	-.37**	.19**	-.34**	1

$p < .001^{***}$, $p < 0.05^{**}$, $p < .01^*$

4.2 Correlation Analysis

Table: 4.2, presents the correlations for theoretical variables. Core self-evaluation was significantly correlated with felt obligation for constructive change ($r=.37$, $p < .05$), supervisory delegation ($r=.31$, $p < .05$), emotion regulation ($r=.35$, $p < .05$), promotive voice ($r=.38$, $p < .05$), prohibitive voice ($r=.25$, $p < .05$), hatred ($r=-.02$, $p < .05$), perceived inclusion ($r=.13$, $p < .05$) and perceived exclusion ($r=.03$, $p > .05$). Supervisory delegation was significantly correlated with felt obligation for constructive change ($r=.34$, $p < .05$), emotion regulation ($r=.42$, $p < .05$), promotive voice ($r=.42$, $p < .05$), prohibitive voice ($r=.36$, $p < .05$), hatred ($r=-.08$, $p > .05$), perceived inclusion ($r=.09$, $p < .01$) and perceived exclusion ($r=.13$, $p < .05$) and in the expected direction. Felt obligation for constructive change was significantly correlated with promotive voice ($r=.38$, $p < .05$), prohibitive voice ($r=.16$, $p < .05$), hatred ($r=-.16$, $p < .05$), perceived inclusion ($r=.18$, $p < .05$) and perceived exclusion ($r=-.04$, $p > .05$) and in the expected direction. Emotion Regulation was significantly correlated with promotive voice ($r=.36$, $p < .05$), prohibitive voice ($r=.22$, $p < .05$), hatred ($r=-.13$, $p < .05$), perceived inclusion ($r=.10$, $p < .01$) and perceived exclusion ($r=.04$, $p > .05$) and in the expected direction.

4.3 Test of Hypotheses

4.3.1 Direct Paths

Following hypothesis were tested to find out the impact of core self-evaluation and supervisory delegation over outcomes felt obligation for constructive change, emotion regulation over outcomes.

4.3.1.1 Test of Direct Hypothesis

H₁: Core self-evaluation is positively related to promotive voice.

H₂: Core self-evaluation is positively related to prohibitive voice.

H₃: There is a positive relationship between supervisory delegation and promotive voice behaviour.

H₄: There is a positive relationship between supervisory delegation and prohibitive voice behaviour.

H₅: There is a positive relationship between core self-evaluation and felt obligation for constructive change.

H₈: There is a positive relationship between supervisory delegation and felt obligation for constructive change.

H₉: Felt obligation for constructive change leads to promotive voice.

H₁₀: Felt obligation for constructive change leads to prohibitive voice.

H₁₃: There is a positive relationship between core self-evaluation and emotion regulation.

H₁₄: There is a positive relationship between emotion regulation and promotive voice.

H₁₅: There is a positive relationship between emotion regulation and prohibitive voice.

H₁₈: There is a positive relationship between supervisory delegation and emotion regulation.

H₂₁: There is a negative relationship between promotive voice and managerial hatred.

H₂₂: There is a positive relationship between prohibitive voice and managerial hatred.

H₂₃: There is a positive relationship between promotive voice and workplace inclusion.

H₂₄: There is a negative relationship between prohibitive voice and workplace inclusion.

H₂₅: There is a negative relationship between promotive voice and perception of workplace exclusion.

H₂₆: There is positive relationship prohibitive voice and perception of workplace exclusion.

The findings of the SEM model for direct paths are shared in **Table: 4.3**. Findings given under path coefficients showed that supervisory delegation and core self-evaluation are significantly influencing the outcomes. The significance level is shown through p-value, and standard error is shown through S.E.

TABLE 4.3: Direct Paths

H	Structural Path	Path Coefficients	S.E	p
H:1	Core self-evaluation → promotive voice	0.30	0.046	***
H:2	Core self-evaluation → prohibitive voice	0.28	0.054	***
H:3	Supervisory delegation → promotive voice behavior	0.39	0.041	***
H:4	Supervisory delegation → prohibitive voice behavior.	0.38	0.048	***
H:5	Core self-evaluation → felt obligation for constructive change.	0.36	0.045	***
H:8	supervisory delegation → felt obligation for constructive change	0.30	0.041	***
H:9	Felt obligation for constructive change → promotive voice	0.39	0.047	***
H:10	Felt obligation for constructive change → prohibitive voice	0.19	0.056	***
H:13	core self-evaluation → emotion regulation	0.39	0.049	***
H:14	emotion regulation → promotive voice	0.26	0.058	***
H:15	emotion regulation → prohibitive voice	0.33	0.043	***
H:18	Supervisory delegation → emotion regulation.	0.37	0.038	***
H:21	promotive voice → managerial hatred.	-0.31	0.056	***
H:22	prohibitive voice → managerial hatred	0.14	0.052	0.004
H:23	promotive voice → workplace inclusion.	0.38	0.051	***
H:24	Prohibitive voice → workplace inclusion.	0.08	0.048	0.09
H:25	promotive voice → perception of workplace exclusion.	0.05	0.057	0.33
H:26	prohibitive voice → perception of workplace exclusion	0.48	0.044	***

*p < .05, **p < .01, ***p < .001

Structural Equation Modeling was used through AMOS to test the hypothesis of the study. Results are shown in **Table: 4.3**. All direct relationships were assessed initially.

Direct relationships were checked first, so the first hypothesis was that core self-evaluation is significantly related to promotive voice behavior. Results confirmed the relationship as shown through the regression coefficient ($\beta = .30$, S.E= .026, $p < .001$). Hypothesis 2 states that core self-evaluation is significantly related to prohibitive voice and result confirmed the relationship through regression coefficient ($\beta = .28$, S.E= .054, $p < .001$). Hypothesis 3 states that supervisory delegation is significantly related to promotive voice and result confirmed the relationship through regression coefficient ($\beta = .39$, S.E= .041, $p < .001$). Hypothesis 4 states that core self-evaluation is significantly related to prohibitive voice and result confirmed the relationship through regression coefficient ($\beta = .38$, S.E= .048, $p < .001$). Hypothesis 5 states that core self-evaluation is significantly related to the felt obligation for constructive change, and the result confirmed the relationship through regression coefficient ($\beta = .36$, S.E= .045, $p < .001$). Hypothesis 8 states that supervisory delegation is significantly related with felt obligation for constructive change and result confirmed the relationship through regression coefficient ($\beta = .30$, S.E= .041, $p < .001$). Hypothesis 9 states that felt obligation for constructive change is significantly related to promotive voice and result confirmed the relationship through regression coefficient ($\beta = .36$, S.E= .045, $p < .001$). Hypothesis 10 states that felt obligation for constructive change is significantly related to prohibitive voice and result confirmed the relationship through regression coefficient ($\beta = .19$, S.E= .056, $p < .001$).

Hypothesis 13 states that core self-evaluation is significantly related with emotion regulation and result confirmed the relationship through regression coefficient ($\beta = .39$, S.E= .049, $p < .001$). Hypothesis 14 states that emotion regulation is significantly related with promotive voice and result confirmed the relationship through regression coefficient ($\beta = .26$, S.E= .058, $p < .001$). Hypothesis 15 states that emotion regulation is significantly related with prohibitive voice and result confirmed the relationship through regression coefficient ($\beta = .33$, S.E= .043, $p < .001$). Hypothesis 18 states that supervisory delegation is significantly related

with emotion regulation and result confirmed the relationship through regression coefficient ($\beta = .37$, S.E= .038, $p < .001$).

Both types of voice i.e. promotive voice, and prohibitive voice was regressed with outcomes that are workplace inclusion, workplace exclusion and managerial hatred. So Hypothesis 21 states that promotive voice is significantly related to managerial hatred and result confirmed the relationship through regression coefficient ($\beta = -.31$, S.E= .56, $p < .001$). Hypothesis 22 states that prohibitive voice is significantly related to managerial hatred and result confirmed the relationship through regression coefficient ($\beta = .14$, S.E= .052, $p < .004$). Hypothesis 23 states that promotive voice is significantly related to workplace inclusion, and the result confirmed the relationship through regression coefficient ($\beta = .38$, S.E= .051, $p < .001$). Hypothesis 24 states that prohibitive voice is significantly related to workplace inclusion, and result were insignificant through regression coefficient ($\beta = .08$, S.E= .048, $p > .05$). Hypothesis 25 states that promotive voice is significantly related to workplace exclusion, and result confirmed the relationship through regression coefficient ($\beta = .05$, S.E= .057, $p > .05$). Hypothesis 26 states that prohibitive voice is significantly related to workplace exclusion, and the result confirmed the relationship through regression coefficient ($\beta = .48$, S.E= .044, $p < .001$).

4.3.2 Mediation Hypothesis

Following hypothesis were developed to test the mediation of felt obligation for constructive change and emotion regulation between antecedents and voice behavior. Results are shown in Table.

Hypothesis 6: Felt Obligation for constructive change mediates the relationship between core self-evaluation and promotive Voice.

Hypothesis 7: Felt obligation for constructive change mediates the relationship between core self-evaluation and prohibitive voice.

Hypothesis 11: Felt obligation for constructive change mediates the relationship between supervisory delegation and promotive voice behavior.

Hypothesis 12: Felt obligation for constructive change mediates the relationship

between supervisory delegation and prohibitive voice behavior.

Hypothesis 16: Emotion Regulation mediates the relationship between core self-evaluation and promotive voice.

Hypothesis 17: Emotion Regulation mediates the relationship between core self-evaluation and prohibitive voice.

Hypothesis 19: Emotion Regulation mediates the relationship between supervisory delegation and promotive voice.

Hypothesis 20: Emotion Regulation mediates the relationship between supervisory delegation and prohibitive voice.

Mediation hypotheses were checked through AMOS at 95 % Bias Corrected Confidence interval with the upper and lower limit. Results are shown in **Table: 4.4**.

Hypothesis 6 states that felt obligation for constructive change mediates the relationship between core self-evaluation and promotive voice. At 95% BC bootstrap Confidence Interval of .12 and .29 and regression coefficient ($\beta=.19$, $p<.05$) shows that felt obligation mediated the relationship between core self-evaluation and promotive voice.

Hypothesis 7 states that felt obligation for constructive change mediates the relationship between core self-evaluation and prohibitive voice. At 95% BC Bootstrap Confidence Interval of -.02 and .12 and regression coefficient ($\beta=.04$, $p>.05$) shows that felt obligation did not mediate the relationship between core self-evaluation and prohibitive voice. So this hypothesis was rejected.

Hypothesis 11 states that felt obligation for constructive change mediates the relationship between supervisory delegation and promotive voice. At 95% BC bootstrap Confidence Interval of .10 and .27 and regression coefficient ($\beta=.17$, $p<.05$) shows that felt obligation mediated the relationship between supervisory delegation and promotive voice.

Hypothesis 12 states that felt obligation for constructive change mediates the relationship between supervisory delegation and prohibitive voice. At 95% BC bootstrap Confidence Interval of -.01 and .01 and regression coefficient ($\beta=.00$, $p>.05$) shows that felt obligation does not mediate the relationship between supervisory delegation and prohibitive voice. So this hypothesis was rejected.

Hypothesis 16 states that emotion regulation mediates the relationship between

core self-evaluation and promotive voice. At 95% BC bootstrap Confidence Interval of .06 and .20 and regression coefficient ($\beta=.12$ $p<.05$) shows that emotion regulation mediated the relationship between core self-evaluation and promotive voice.

Hypothesis 17 states that emotion regulation mediates the relationship between core self-evaluation and prohibitive voice. At 95% BC bootstrap Confidence Interval of .02 and .14 and regression coefficient ($\beta=.07$ $p<.05$) shows that emotion regulation mediated the relationship between core self-evaluation and prohibitive voice.

Hypothesis 19 states that emotion regulation mediates the relationship between supervisory delegation and promotive voice. At 95% BC bootstrap Confidence Interval of .04 and .22 and regression coefficient ($\beta=.13$ $p<.05$) shows that emotion regulation mediated the relationship between supervisory delegation and promotive voice.

Hypothesis 20 states that emotion regulation mediates the relationship between supervisory delegation and prohibitive voice. At 95% BC bootstrap Confidence Interval of -.07 and .10 and regression coefficient ($\beta=.01$ $p>.05$) shows that emotion regulation does not mediate the relationship between supervisory delegation and prohibitive voice. So this hypothesis was rejected.

4.3.3 Moderation Hypothesis

Moderation of voice climate and the perceived risk was checked through Process Macro 2.16 by Hayes 2013. Interaction terms for subsequent moderation effects were also plotted to see the direction. Results are given in Table.

Hypothesis 27: Voice climate moderates the relationship between felt obligation for constructive change and promotive voice behavior such that relationship is stronger when the voice climate is high.

Hypothesis 28: Voice climate moderates the relationship between felt obligation for constructive change and prohibitive voice behavior such that relationship is stronger when the voice climate is high.

TABLE 4.4: Results on the Mediating Roles of Felt Obligation for Constructive Change and Emotion Regulation

H	Bootstrapping	Path Coefficient	BC (95%) LLCI-ULCI	p
H:6	core self-evaluation → felt obligation for constructive change → pro-motive voice	0.19	(.12, .29)	0.000
H:7	core self-evaluation → felt obligation for constructive change → prohibitive voice	0.04	(-.02, .12)	0.154
H:11	supervisory delegation → felt obligation for constructive change → promotive voice	0.17	(.10, .27)	0.001
H:12	supervisory delegation → felt obligation for constructive change → prohibitive voice	0.00	(-.01, .01)	0.926
H:16	core self-evaluation → emotion regulation → promotive voice	0.12	(.06, .20)	0.001
H:17	core self-evaluation → emotion regulation → prohibitive voice	0.07	(.02, .14)	0.010
H:19	supervisory delegation → emotion regulation → promotive voice	0.13	(.04, .22)	0.001
H:20	supervisory delegation → emotion regulation → prohibitive voice	0.01	(-.07, .10)	0.740

Notes: BC means bias-corrected, 2,000-bootstrap samples, CI=Confidence interval.

Hypothesis 29: Voice climate moderates the relationship between emotion regulation and promotive voice behavior such that relationship is stronger when the voice climate is high.

Hypothesis 30: Voice climate moderates the relationship between emotion regulation and prohibitive voice behavior such that relationship is stronger when the voice climate is high.

Hypothesis 31: Perceived risk moderates the relationship between promotive voice behavior and managerial hatred such that the negative relationship is strengthened when perceived risk is high.

Hypothesis 32: Perceived risk moderates the relationship between prohibitive voice behavior and managerial hatred such that relationship is weakened when perceived risk is high.

Hypothesis 33: Perceived risk moderates the relationship between promotive voice behavior and workplace inclusion such that relationship is stronger when perceived risk is high.

Hypothesis 34: Perceived risk moderates the relationship between prohibitive voice behavior and workplace inclusion such that the negative relationship is weakened when perceived risk is high.

Hypothesis 35: Perceived risk moderates the relationship between promotive voice behavior and workplace exclusion such that the negative relationship is strengthened when perceived risk is high.

Hypothesis 36: Perceived risk moderates the relationship between prohibitive voice behavior and workplace exclusion such that the relationship is weakened when perceived risk is high.

Hypothesis 27 states that voice climate moderates the relationship between felt obligation for constructive change and promotive voice such that relationship is stronger when the voice climate is high. Model 1 by Hayes 2013 was applied. At BC 95%, CI was .00 and .21 with regression coefficient ($\beta = .10$, $p < .05$). Slope test was performed and shown in **Graph 4.1**.

TABLE 4.5: Moderation of Voice Climate between Felt Obligation for Constructive Change and Promotive Voice

H 27	Predictor	Promotive Voice	β	R^2	ΔR^2	LL	UL
	Felt obligation for constructive change		0.35			0.24	0.45
	Voice climate		0.11			0.03	0.18
	FOCC X Voice Climate		0.10	0.17	0.08	0.00	0.21

Notes: n=415, UL=upper limit, LL=lower limit, Bootstrapping =5000.

Graph 4.1

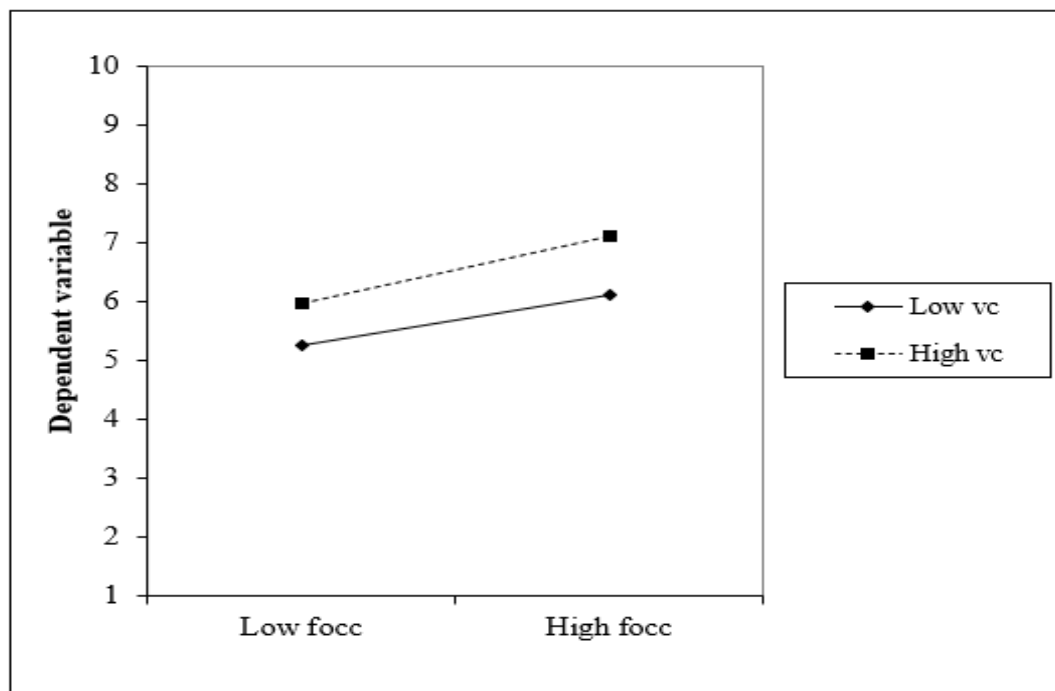

FIGURE 4.1: Moderation of Voice Climate between FOCC and Promotive Voice

Hypothesis 28 states that voice climate moderates the relationship between felt obligation for constructive change and prohibitive voice such that relationship is stronger when the voice climate is high. Model 1 by Hayes 2013 was applied. At BC95% , CI was -.12 and .11 with regression coefficient ($\beta = -.00$, $p > .05$). Results

show that voice climate does not moderate the relationship between felt obligation for constructive change and prohibitive voice.

TABLE 4.6: Moderation of Voice Climate between Felt Obligation for Constructive Change and Prohibitive Voice

H 28	Predictor	Prohibitive Voice				
		β	R^2	ΔR^2	LL	UL
	Felt obligation for constructive change	0.15			0.03	0.25
	Voice climate	0.09			0.00	0.19
	FOCC X Voice Climate	-0.00	0.04	0.00	-0.12	0.11

Notes: n=415, UL=upper limit, LL=lower limit, Bootsraping =5000.

Hypothesis 29 states that voice climate moderates the relationship between emotion regulation and promotive voice such that relationship is stronger when the voice climate is high. Model 1 by Hayes 2013 was applied. At BC95% , CI was .11 and .35 with regression coefficient ($\beta = .23$, $p < .05$). Slope test was performed and shown in **Graph 4.2**. Results show that voice climate moderates the relationship between emotion regulation and promotive voice.

TABLE 4.7: Moderation of Voice Climate between Emotion Regulation and Promotive Voice

H 29	Predictor	Promotive Voice				
		β	R^2	ΔR^2	LL	UL
	Emotion Regulation	0.31			0.21	0.41
	Voice Climate	0.13			0.05	0.20
	Emotion Regulation X Voice Climate	0.23	0.18	0.03	0.11	0.35

Notes: n=415, UL=upper limit, LL=lower limit, Bootsraping =5000

Graph 4.2

FIGURE 4.2: Moderation of Voice Climate between Emotion Regulation and Promotive Voice

Hypothesis 30 states that voice climate moderates the relationship between emotion regulation and prohibitive voice such that relationship is stronger when the voice climate is high. Model 1 by Hayes 2013 was applied. At BC 95%, CI was .05 and .33 with regression coefficient ($\beta = .19$, $p < .05$). Slope test was performed and shown in **Graph 4.3**. Results show that voice climate moderates the relationship between emotion regulation and prohibitive voice.

TABLE 4.8: Moderation of Voice Climate between Emotion Regulation and Prohibitive Voice

H 30	Predictor	Prohibitive Voice				
		β	R^2	ΔR^2	LL	UL
	Emotion Regulation	0.21			0.09	0.33
	Voice Climate	0.09			0.01	0.18
	Emotion Regulation X Voice Climate	0.19	0.07	0.01	0.05	0.33

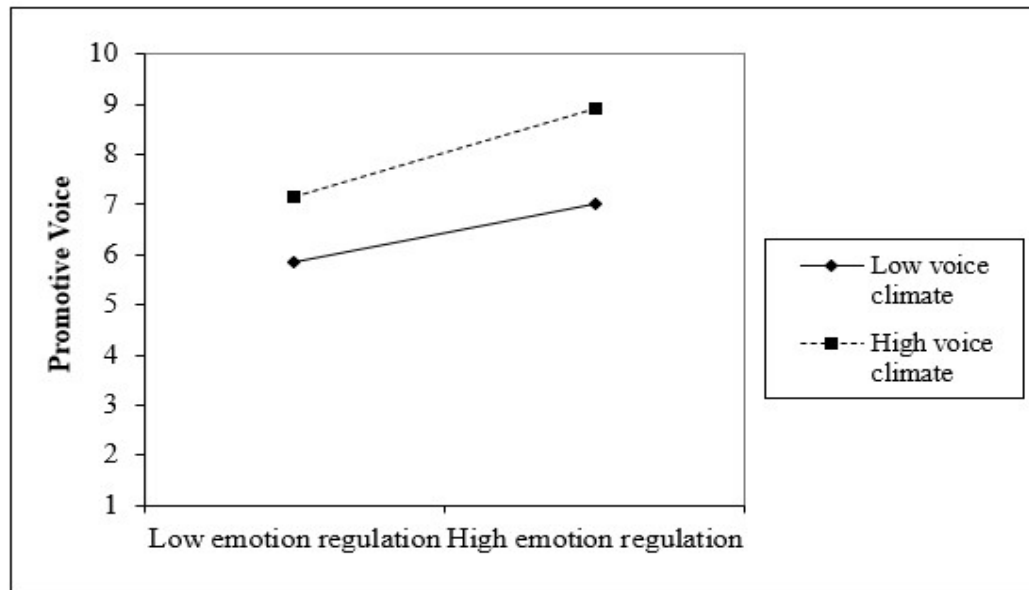
Notes: $n=415$, UL=upper limit, LL=lower limit, Bootstrapping =5000.

Graph 4.3

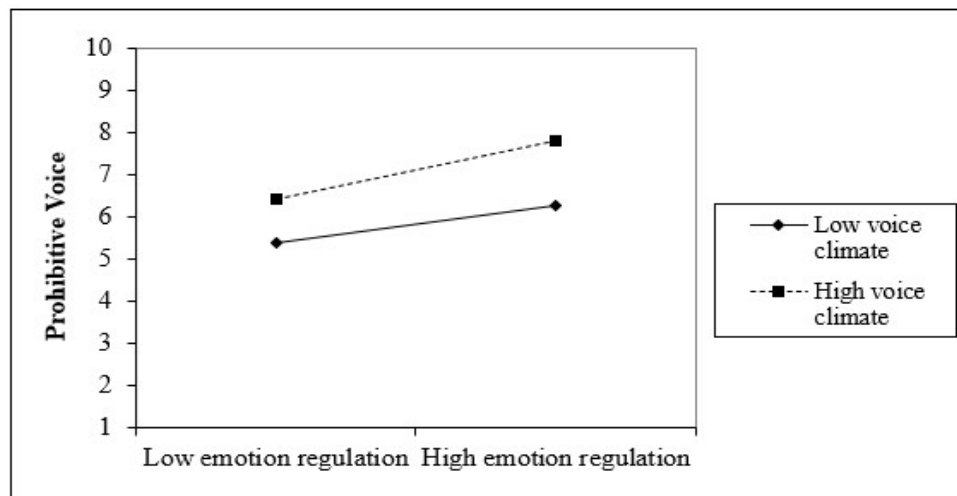

FIGURE 4.3: Moderation of Voice Climate between Emotion Regulation and Prohibitive Voice

Hypothesis 31 states that perceived risk moderates the relationship between promotive voice and managerial hatred such that the negative relationship is strengthened when perceived risk is high.

Model 1 by Hayes 2013 was applied. At BC 95%, CI was -.51 and -.31 with regression coefficient ($\beta = -.41, p < .05$). Slope test was performed and shown in Figure. Results show that perceived risk moderates the relationship between promotive voice and managerial hatred.

TABLE 4.9: Moderation of Perceived Risk between Promotive Voice and Managerial Hatred

H 31	Predictor	Managerial Hatred				
		β	R^2	ΔR^2	LL	UL
	Promotive Voice	-0.28			-0.38	-0.18
	Perceived Risk	-0.30			-0.38	-0.23
	Promotive Voice X Perceived Risk	-0.41	0.30	0.10	-0.51	-0.31

Notes: n=415, UL=upper limit, LL=lower limit, Bootstrapping =5000.

Graph 4.4

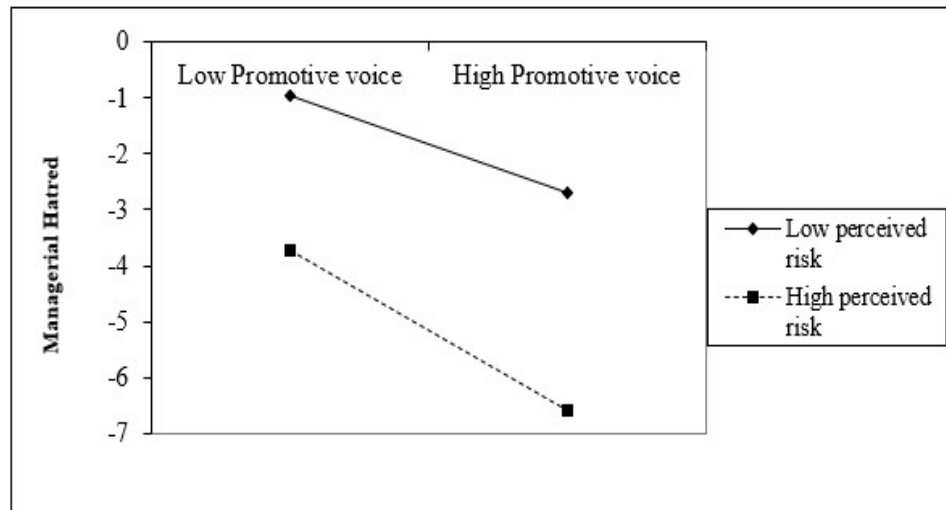

FIGURE 4.4: Moderation of Perceived Risk between Promotive Voice and Managerial Hatred

Hypothesis 32 states that perceived risk moderates the relationship between prohibitive voice and managerial hatred such that relationship is weakened when perceived risk is high.

Model 1 by Hayes 2013 was applied. At BC 95%, CI was -.39 and -.20 with regression coefficient ($\beta = -.30$, $p < .05$). Slope test was performed and shown in Figure. Results show that perceived risk moderates the relationship between prohibitive voice and managerial hatred.

TABLE 4.10: Moderation of Perceived Risk between Prohibitive Voice and Managerial Hatred

H 32	Predictor	Managerial Hatred				
		β	R^2	ΔR^2	LL	UL
	Prohibitive Voice	0.13			0.04	0.22
	Perceived Risk	-0.32			-0.39	-0.24
	Prohibitive Voice X Perceived Risk	-0.30	0.22	0.07	-0.39	-0.20

Notes: $n=415$, UL=upper limit, LL=lower limit, Bootstrapping =5000.

Graph 4.5

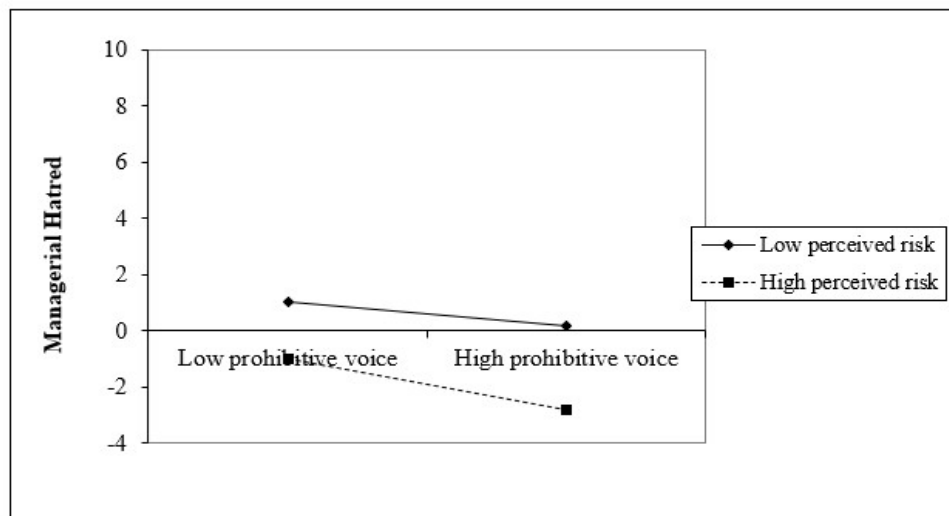

FIGURE 4.5: Moderation of Perceived Risk between Prohibitive Voice and Managerial Hatred

Hypothesis 33 states that perceived risk moderates the relationship between promotive voice and workplace inclusion such that relationship is stronger when perceived risk is high. Model 1 by Hayes 2013 was applied. At BC 95%, CI was .02 and -.19 with regression coefficient ($\beta = .13, p < .05$).

Slope test was performed and shown in **Graph 4.6**. Results show that perceived risk moderates the relationship between promotive voice and workplace inclusion.

TABLE 4.11: Moderation of Perceived Risk between Promotive Voice and Perceived Workplace Inclusion

H 33	Predictor	Perceived Workplace Inclusion				
		β	R^2	ΔR^2	LL	UL
	Promotive Voice	0.36			0.26	0.46
	Perceived Risk	0.12			0.04	0.19
	Promotive Voice X Perceived Risk	0.13	0.16	0.01	0.02	0.19

Notes: n=415, UL=upper limit, LL=lower limit, Bootstrapping =5000.

Graph 4.6

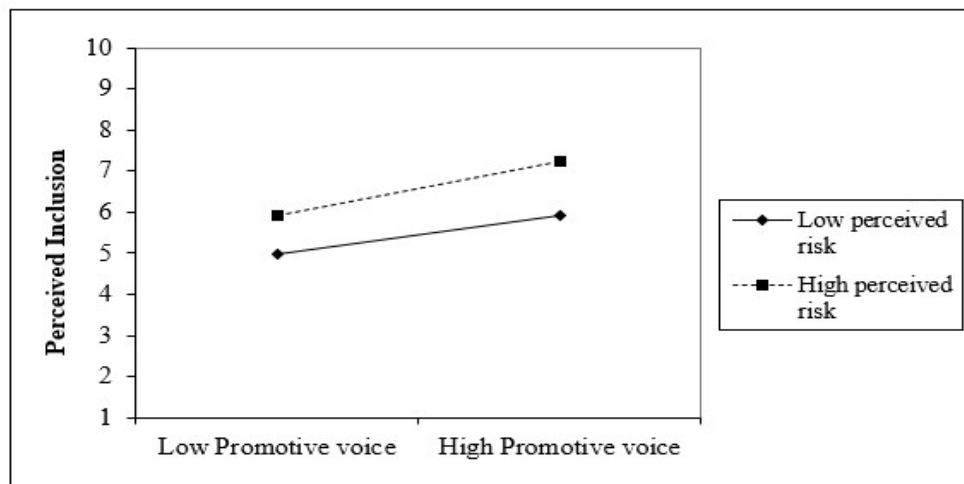

FIGURE 4.6: Moderation of Perceived Risk between Promotive Voice and Workplace Inclusion

Hypothesis 34 states that perceived risk moderates the relationship between prohibitive voice and workplace inclusion such that the negative relationship is weakened when perceived risk is high. Model 1 by Hayes 2013 was applied. At BC 95%, CI was -.08 and .11 with regression coefficient ($\beta = .01$, $p > .05$). Results show that perceived risk does not moderate the relationship between prohibitive voice and workplace inclusion.

TABLE 4.12: Moderation of Perceived Risk between Prohibitive Voice and Perceived Workplace Inclusion

H 34	Predictor	Perceived workplace Inclusion				
		β	R^2	ΔR^2	LL	UL
	Prohibitive Voice	0.09			0.00	0.19
	Perceived Risk	0.05			0.07	0.23
	Prohibitive Voice X Perceived Risk	0.01	0.05	0.00	-0.08	0.11

Notes: $n=415$, UL=upper limit, LL=lower limit, Bootstrapping =5000.

Hypothesis 35 states that perceived risk moderates the relationship between promotive voice and workplace exclusion such that the negative relationship is strengthened when perceived risk is high. Model 1 by Hayes 2013 was applied. At BC 95%, CI was -.37 and -.15 with regression coefficient ($\beta = -.26$, $p < .05$). Slope test was

performed and shown in **Graph 4.7**. Results show that perceived risk moderate the relationship between promotive voice and workplace exclusion.

TABLE 4.13: Moderation of Perceived Risk between Promotive Voice and Perceived Workplace Exclusion

H 35	Predictor	Perceived Workplace Exclusion				
		β	R^2	ΔR^2	LL	UL
	Promotive Voice	0.08			-0.02	0.18
	Perceived Risk	-0.29			-0.37	-0.21
	Promotive Voice X Perceived Risk	-0.26	0.18	0.04	-0.37	-0.15

Notes: n=415, UL=upper limit, LL=lower limit, Bootsraping =5000.

Graph 4.7

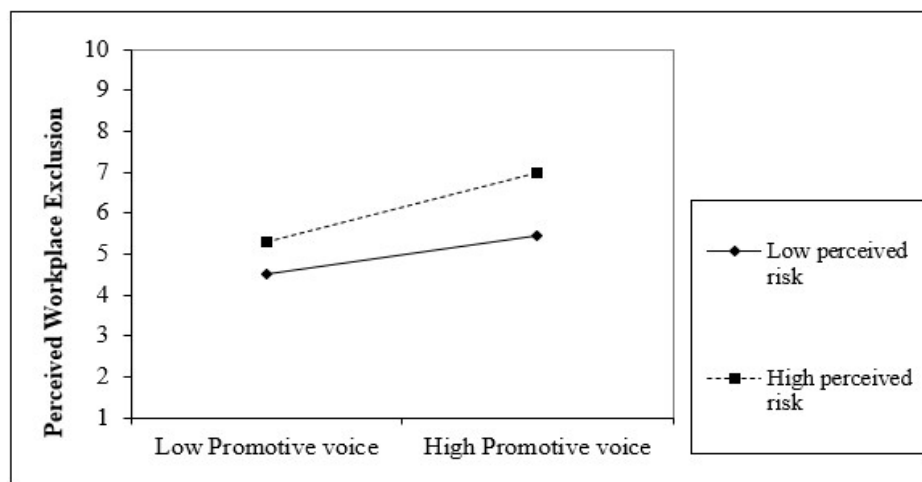

FIGURE 4.7: Moderation of Perceived Risk between Promotive Voice and Workplace Exclusion

Hypothesis 36 states that perceived risk moderates the relationship between prohibitive voice and workplace exclusion such that the relationship is weakened when perceived risk is high. Model 1 by Hayes 2013 was applied. At BC 95%, CI was -.25 and -.08 with regression coefficient ($\beta = -.17$, $p < .05$). Slope test was performed and shown in **Graph 4.8**. Results show that perceived risk moderate the relationship between prohibitive voice and workplace exclusion.

TABLE 4.14: Moderation of Perceived Risk between Prohibitive Voice and Perceived Workplace Exclusion

H 36	Predictor	Perceived Workplace Exclusion				
		β	R^2	ΔR^2	LL	UL
	Prohibitive Voice	0.47			0.39	0.55
	Perceived Risk	-0.20			-0.33	-0.19
	Prohibitive Voice X Perceived Risk	-0.17	0.35	0.02	-0.25	-0.08

Notes: n=415, UL=upper limit, LL=lower limit, Bootsraping =5000.

Graph 4.8

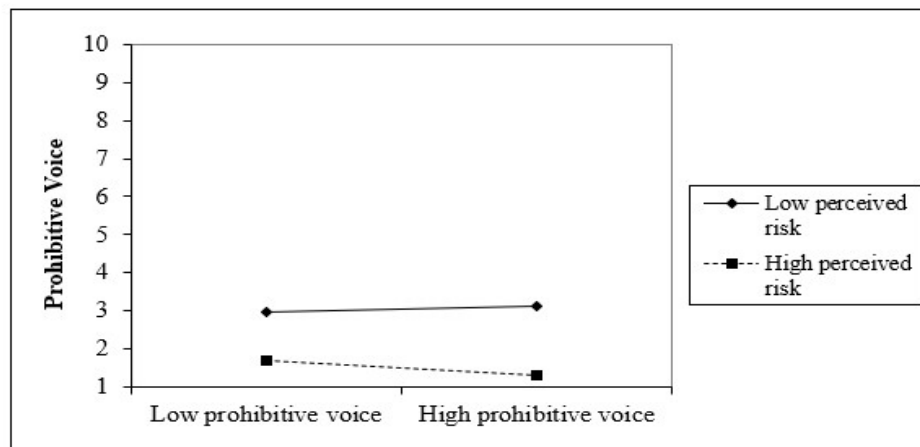

FIGURE 4.8: Moderation of Perceived Risk between Prohibitive Voice and Workplace Exclusion

4.4 Structural Equation Modeling Results

In order to reconfirm the results of Model 1 of preacher and Hayes process Macros, the results were also calculated through structural equation modeling in AMOS-23 by testing all the links in a single model. There was no significance difference found in the results of AMOS-23 and preacher and Hayes macros. All the results of SEM checked on AMOS-23 confirmed the previous results checked through Model -1 of Preacher and Hayes. Results of whole model also confirmed the previously rejected hypothesis.

TABLE 4.15: Structural Equation Modeling Results

H	Direct Hypothesis	β	S.E	p		
H:1	CSE \rightarrow PMV	0.16	0.05	***		
H:2	CSE \rightarrow PHV	0.10	0.05	***		
H:3	SD \rightarrow PMV	0.19	0.04	***		
H:4	SD \rightarrow PHV	0.18	0.05	***		
H:5	CSE \rightarrow FOCC	0.27	0.04	***		
	Mediation Hypothesis	β	S.E	LL	UL	
H:6	CSE \rightarrow FOCC \rightarrow PMV	0.18	0.04	0.11	0.27	
H:7	CSE \rightarrow FOCC \rightarrow PHV	0.04	0.03	-0.02	0.11	
	Direct Hypothesis	β	S.E	p		
H:8	SD \rightarrow FOCC	0.25	0.04	***		
H:9	FOCC \rightarrow PMV	0.30	0.05	***		
H:10	FOCC \rightarrow PHV	0.20	0.06	***		
	Mediation Hypothesis	β	S.E	LL	UL	
H:11	SD \rightarrow FOCC \rightarrow PMV	0.17	0.06	0.09	0.26	
H:12	SD \rightarrow FOCC \rightarrow PHV	0.00	0.02	-0.01	0.01	
	Direct Hypothesis	β	S.E	p		
H:13	CSE \rightarrow ER	0.25	0.049	***		
H:14	ER \rightarrow PMV	-0.07	0.058	***		
H:15	ER \rightarrow PHV	-0.21	0.063	***		
	Mediation Hypothesis	β	S.E	LL	UL	
H:16	CSE \rightarrow ER \rightarrow PMV	0.12	0.03	0.05	0.02	
H:17	CSE \rightarrow ER \rightarrow PHV	0.07	0.01	0.02	0.12	
	Direct Hypothesis	β	S.E	p		
H:18	SD \rightarrow ER	0.35	0.04	***		
	Mediation Hypothesis	β	S.E	LL	UL	
H:19	SD \rightarrow ER \rightarrow PMV	0.13	0.05	0.03	0.20	
H:20	SD \rightarrow ER \rightarrow PHV	0.01	0.02	-0.06	0.07	
	Direct Hypothesis	β	S.E	p		
H:21	PMV \rightarrow MH	-0.25	0.06	***		
H:22	PHV \rightarrow MH	0.60	0.04	***		
H:23	PMV \rightarrow PWIN.	0.15	0.05	***		
H:24	PHV \rightarrow PWIN.	0.09	0.04	0.057		
H:25	PMV \rightarrow PWEX	-0.04	0.05	0.18		
H:26	PHV \rightarrow PWEX	0.73	0.03	***		

	Moderation Hypothesis	β	S.E	LL	UL
H:27	FOCC*VC \rightarrow PMV	0.10	0.02	0.00	0.21
H:28	FOCC*VC \rightarrow PHV	0.00	0.01	-0.11	0.10
H:29	ER*VC \rightarrow PMV	0.21	0.02	0.10	0.30
H:30	ER*VC \rightarrow PHV	0.17	0.03	0.06	0.36
H:31	PMV*PR \rightarrow MH	-0.40	0.05	-0.52	-0.32
H:32	PHV*PR \rightarrow MH	-0.30	0.05	-0.38	-0.18
H:33	PMV*PR \rightarrow PWIN	0.13	0.04	0.02	0.17
H:34	PHV*PR \rightarrow PWIN	0.01	0.07	-0.07	0.09
H:35	PMV*PR \rightarrow PWEX	-0.25	0.03	-0.34	-0.13
H:36	PHV*PR \rightarrow PWEX	-0.01	0.03	-0.26	-0.09

CSE=Core Self Evaluation, SD=Supervisory Delegation, FOCC=Felt Obligation for Constructive Change, ER=Emotion Regulation, PMV=Promotive Voice, PHV = Prohibitive Voice, MH=Managerial Hatred, PWIN = Perceived Workplace Inclusion, PWEX = Perceived Workplace Exclusion, VC=Voice Climate, PR = Perceived Risk.

4.5 Summary of Hypotheses Status

Hypothesis	Statement	Status
H 1	Core self-evaluation is positively related to promotive voice	Supported
H 2	Core self-evaluation is positively related to prohibitive voice	Supported
H 3	There is a positive relationship between supervisory delegation and promotive voice behavior.	Supported
H 4	There is a positive relationship between supervisory delegation and prohibitive voice behavior	Supported
H 5	There is a positive relationship between core self-evaluation and felt obligation for constructive change.	Supported

H 6	Felt Obligation for constructive change mediates the relationship between core self-evaluation and promotive voice	Supported
H 7	Felt obligation for constructive change mediates the relationship between core self-evaluation and prohibitive voice	Not Supported
H 8	There is a positive relationship between supervisory delegation and felt obligation for constructive change.	Supported
H 9	Felt obligation for constructive change leads to promotive voice	Supported
H 10	Felt obligation for constructive change leads to prohibitive voice	Supported
H 11	Felt obligation for constructive change mediates the relationship between supervisory delegation and promotive voice behavior.	Supported
H 12	Felt obligation for constructive change mediates the relationship between supervisory delegation and prohibitive voice behavior.	Not Supported
H 13	There is a positive relationship between core self-evaluation and emotion regulation	Supported
H 14	There is a positive relationship between emotion regulation and promotive voice	Supported
H 15	There is a positive relationship between emotion regulation and prohibitive voice	Supported
H 16	Emotion Regulation mediates the relationship between core self-evaluation and promotive voice	Supported
H 17	Emotion Regulation mediates the relationship between core self-evaluation and prohibitive voice	Supported
H 18	There is a positive relationship between supervisory delegation and emotion regulation	Supported

H 19	Emotion Regulation mediates the relationship between supervisory delegation and promotive voice	Supported
H 20	Emotion Regulation mediates the relationship between supervisory delegation and prohibitive voice	Not Supported
H 21	There is a negative relationship between promotive voice and managerial hatred	Supported
H 22	There is a positive relationship between prohibitive voice and managerial hatred	Supported
H 23	There is a positive relationship between promotive voice and workplace inclusion.	Supported
H 24	There is a negative relationship between prohibitive voice and workplace inclusion.	Not Supported
H 25	There is a negative relationship between promotive voice and perception of workplace exclusion	Not Supported
H 26	There is a positive relationship prohibitive voice and perception of workplace exclusion	Supported
H 27	Voice climate moderates the relationship between felt obligation for constructive change and promotive voice behavior such that relationship is stronger when the voice climate is high.	Supported
H 28	Voice climate moderates the relationship between felt obligation for constructive change and prohibitive voice behavior such that relationship is stronger when the voice climate is high.	Not Supported
H 29	Voice climate moderates the relationship between emotion regulation and promotive voice behavior such that relationship is stronger when the voice climate is high.	Supported

H 30	Voice climate moderates the relationship between emotion regulation and prohibitive voice behavior such that relationship is stronger when the voice climate is high	Supported
H 31	Perceived risk moderates the relationship between promotive voice behavior and managerial hatred such that the negative relationship is strengthened when perceived risk is high.	Supported
H 32	Perceived risk moderates the relationship between prohibitive voice behavior and managerial hatred such that relationship is weakened when perceived risk is high.	Supported
H 33	Perceived risk moderates the relationship between promotive voice behavior and workplace inclusion such that relationship is stronger when perceived risk is high	Supported
H 34	Perceived risk moderates the relationship between prohibitive voice behavior and workplace inclusion such that the negative relationship is weakened when perceived risk is high.	Not Supported
H 35	Perceived risk moderates the relationship between promotive voice behavior and workplace exclusion such that the negative relationship is strengthened when perceived risk is high.	Supported
H 36	Perceived risk moderates the relationship between prohibitive voice behavior and workplace exclusion such that the relationship is weakened when perceived risk is high.	Supported

Chapter 5

Discussion, Implications, Future Directions and Conclusion

This chapter has justifications of hypothesized relationships. Depending upon the results, implications for organizations and their employees have been discussed. Theoretical implications are also given. Future directions have been suggested, as well as the limitations and strengths of the study, are also incorporated.

5.1 Discussion

Drawing on the proactive behavior theory (Parker, Bindle & Strauss, 2010), a conceptual framework was tested. There were total thirty six hypothesis. Out of which eighteen were direct, ten were moderation hypothesis and eight were mediation hypothesis. Seven hypothesis were rejected and twenty nine hypothesis were accepted. All direct and mediation hypotheses were initially checked through AMOS-23 and moderation hypothesis were assessed through Preacher and Hayes Macros. Whole model was then run on SEM on AMOS-23 and results of whole model confirmed the results of previously checked hypotheses. All hypotheses have been discussed through the research questions of the study. Thus research questions of the study are achieving the study objectives and proving that voice behavior is a particular type of proactive behavior triggered by various dispositional and situational characteristics.

5.1.1 Research Question 1: What is the Impact of Core Self-Evaluation and Supervisory Delegation as Individual and Situational Factor in Generating Employee Proactive Behavior i.e. Voice Behavior?

Research question number one was about the impact of dispositional characteristics of individual and situational factors of organization over employees' tendency of engagement in voice behavior.

5.1.1.1 Hypothesis 1 and 2 Core-Self Evaluation and Voice Behavior

The study hypothesized the direct relationship between core self-evaluation and promotive voice behavior and prohibitive voice behavior. Grant et al. (2009) noted that besides taking proactive behaviors as always pro-social, it is equally important to know the conditions upon which senior management may assess' proactive behaviors as constructive. They further extend that voice recipient may interpret the voicer depending upon the personality of the voice or his/her emotional traits. Thus seniors may judge the employees engaging in voice behavior as self-serving individuals or those concerned for constructive improvements of the workplace. Jung (2014) posited about core self-evaluation that people with high CSE are more likely to benefit from the external environment and can cope up effectively with the environment. People with high core self-evaluations are less influenced by undesirable circumstances, including damaged relationships (Karatepe, Haktanir, & Yorganci, 2010; Kammeyer-Mueller, Judge, & Scott, 2009).

The findings have shown that core self-evaluation was significantly and positively related to promotive voice. These findings were consistent with previous study findings (Zhang et al., 2018). People with higher core self-evaluation are more expected to involve in proactive behaviors (Zhang et al. 2018). Voice behavior is proactive in nature, and it tends to challenge the status quo. (Parker & Collins 2010; Morrison & Phelps 1999; Parker et al. 2010). Promotive voice behavior is a show of the concerns for improved organizational functioning (Liang, Farh & Farh, 2012). Thus this process of raising concerns through promotive voice behavior

may also become the source of conflict with other members of the organization (Edmondson, 2003; Detert & Burris, 2007). Employees engaging in promotive voice behavior have to look at the repercussion too associated with this behavior (Morrison, 2011).

Thus an individual personality may play an essential role in determining a person's intention of engagement in promotive voice. Aryee et al. (2013) opinionated that employees self-evaluation affects their engagement in voice behavior. Thus employees with high core self-evaluation are more susceptible to involve in promotive voice behavior because they evaluate themselves as confident to engage in this activity. Core self-evaluation shows that how an individual visualizes himself, his own self-worth, capabilities he possesses and competence (Judge et al., 1997). Core self-evaluation consists of four distinct traits which are self-esteem, self-efficacy, emotional stability and locus of control ((Erez and Judge, 2001; Judge et al., 1997).

Core self-evaluation describes how an individual considers himself for the solution of issues, respects for himself, the ability to have optimism and taking responsibility for actions one engages in. Perceived competence of an individual is said to be correlated with voice behavior (Aryee at al, 2013). The said perceived competence also determines an individual's reaction to stimuli at the workplace. Employees with high core self-evaluation consider themselves as worthy of controlling the environment and situation (Johnson et al., 2008). So employees with high core self-evaluation are more prone to engage in voice behavior, and this study confirmed this notion.

As far as prohibitive voice behavior is concerned, which is raising the concern for practices, ways of doing things that may harm an organization, the study found a significant positive relationship between core self-evaluation and prohibitive voice behavior. Core self-evaluation, as discussed earlier as one's own evaluation about himself. Prohibitive voice behavior is more likely to challenge the status quo as well as has the potential to imbalance the relationships with others at the workplace. Because when one is engaging in prohibitive voice behaviour, he is actually pointing

out about unhealthy work practices and policies that are being flowed from upper management to lower management. Engaging in this specific type of behavior may apprehend top management. So an individual with lower core self-evaluation may never take the risk of this challenge oriented behavior. Results of the study are consistent with this notion that the employees with higher core self-evaluations are more likely to engage in prohibitive voice behavior.

5.1.1.2 Hypothesis 3 and Hypothesis 4 Supervisory Delegation and Voice Behavior

The study hypothesized that there is a direct relationship between supervisory delegation and voice behavior of employees. The indirect relationship between both constructs through felt obligation was also tested. Results revealed significant relationships between the proposed constructs. As voice behavior is about the generation of ideas and suggestions for the organization (Liang, Farh & Farh, 2012), this is only possible when employees feel empowered that their opinions and suggestions would be welcomed (Dvir et al., 2002). When managers delegate responsibilities to the next subsequent level employees, it is the process of empowerment of employees. It shows that there is reciprocal trust between managers and employees. Employees also consider themselves as responsible for the improvement of the organization. As far as promotive voice is concerned, it is the generation of voice and show of concerns for organizational improvement, its practices and processes (Liang, Farh & Farh, 2012). Employee voice is considered as a challenge to the status quo (Ashford et al., 2009). This stands consistent with the notion of Janssen (2005) that role of supervisor as supporting the employee voice is quite crucial for generating employee voice. Suppose employees fear that their voice may not be welcomed by senior management, or they may be snubbed for raising concerns about organizational improvements. In that case, they may not engage in voice behavior. This feeling is ignited by the employees' perception of trust from the delegation of tasks and responsibilities from senior management. Delegation is an empowerment behavior of leaders through which they engage their followers in the decision-making process and entrusting them by sharing

their power (Zhang & Bartol, 2010; Chen et al.,2011; Cheung et al., 2017; Sagnak, 2012). This study confirmed the findings of Gao et al. (2011) that delegating through empowering employees makes them prone to raise concerns about work-related issues. Because delegation acts as an environment which is more open between boss and employee with less hesitation and more free expression of concerns. Other scholars also postulated this notion that this specific type of leadership welcomes the participation of followers and engagement in promotive voice behavior (Martin et al. 2013).

5.1.2 Research Question 2: What is the Role of Cognitive Motivational State and Affect related Process i.e Felt Obligation for Constructive Change and Emotion Regulation Respectively as Possible Mediators between Individual Factor i.e. Core Self-Evaluation, Situational Factor i.e. and Supervisory Delegation and their Outcomes i.e. both Dimensions of Voice Behavior?

Research question number two was about indirect effect of felt obligation for constructive change between core self-evaluation and employee voice behavior. Secondly it also proposed to check the indirect effect of felt obligation for constructive change between supervisory delegation and employee voice behavior. Along with this, role of emotion regulation was assessed between core self-evaluation and employee voice behavior. Secondly it also proposed to check the indirect effect of emotion regulation between supervisory delegation and employee voice behavior.

High core self-evaluation also fosters employees to have more felt obligation for constructive change towards the organization. As an employee with higher core self-evaluation evaluates himself, his competence and self-worth this enabling himself more prone to engage in felt obligation. So hypothesis five was accepted that

there is a relationship between core self-evaluation and felt obligation for constructive change.

5.1.2.1 Hypothesis 6 and 7 Mediation of Felt Obligation for Constructive Change between Core Self-Evaluation and Voice Behavior

Role of felt obligation for constructive change as a mediatory mechanism between core self-evaluation and prohibitive voice behavior has not been supported in this study. Reason for failed mediation of felt obligation between core self-evaluation and prohibitive voice could be that employees with higher core self-evaluation when engaged in felt obligation, are fostered to evaluate the environment for engaging in voice behavior, i.e. prohibitive voice behavior. People with higher core self-evaluation are more concerned about the positive aspects of the environment and they less emphasize negative aspects (Ferris et al, 2013). Thus making them less prone to engage in prohibitive voice behavior through mediation of felt obligation for constructive change.

In cultures like Pakistan, where there is more superficial harmony, employees may consider it more harmonious to remain silent and may not engage in prohibitive voice behavior. Thus felt obligation of an individual who has higher core self-evaluation might force the individual to maintain the terms and relationships with colleagues and seniors. The relationship maintenance may cause imbalance if one may engage in prohibitive voice behavior. The higher the core self-evaluation of an individual, the higher is his felt obligation for constructive change, the lesser he may engage in prohibitive voice behavior. So felt obligation does not mediate between core self-evaluation and prohibitive voice behavior.

5.1.2.2 Hypothesis 8 Supervisory Delegation and Felt Obligation for Constructive Change

When employees are delegated for tasks, they are trusted for making decisions at crucial levels; they consider themselves as obligated towards the workplace and towards tasks, they are responsible for. Thus this delegation by seniors makes them

obligated for constructive change for the organization. Decision-making involvement makes employees more accountable for whatever they do or the tasks they are responsible for. Employees will try to act more responsibly towards the organization. Whereas, if employees are not delegated, and not involved in decision-making process; they would least bother about strategies and decisions coming from senior hierarchies knowing they are not responsible and accountable for any loss or benefit to the organization. Thus results of the study confirmed these notions that supervisory delegation fosters employee felt obligation for constructive change.

Maxwell (2011) stated that the higher you go, the more you become responsible for your action and actions of people around you. So delegating work responsibilities may lead to the felt obligation for constructive change. Consequently higher supervisory delegation fosters employees to feel responsible and motivated about their work. Because it is quite interesting to note that when employees are delegated the tasks and given responsibilities and decision making, they are more likely to experience the responsibility of their action. So hypothesis 8 was accepted that there is a direct relationship between supervisory delegation and felt obligation for constructive change.

5.1.2.3 Hypothesis 9 and 10 Felt Obligation for Constructive Change and Voice Behavior

In one of the study, it was found that people with a stronger sense of obligation for constructive change are more likely to engage in proactive behavior as they consider this behavior more satisfying for them resulting in the greater sense of accomplishment for them (Morrison & Phelps, 1999). Felt obligation for constructive change is related to proactive behavior as it fosters employees for thoroughly analyzing information related to work (Fuller, Marler & Hester, 2006). This is consistent with past studies that people who take responsibility for actions are found to be more vigilant about their duties (McAllister, Mitchell, & Beach, 1979).

Eventually, when employees feel obligated towards the workplace, they consider it as their prime responsibility to talk about the improvement of organization and its practices. We can call this as promotive voice behavior. However, the concept

of felt obligation for constructive change is a relatively newer phenomenon. Some of the previous studies confirmed this notion that felt obligation for constructive change among employees forces them to engage in promotive voice behavior (Liang et al., 2013). Findings of the study confirmed that there is a positive relationship between felt obligation for constructive change and both dimensions of voice behavior i.e. promotive and prohibitive voice behavior.

5.1.2.4 Hypothesis 11 and 12 Mediation of Felt Obligation for Constructive Change between Supervisory Delegation and Voice Behavior

As far as the role of felt obligation for constructive change is concerned for mediation between supervisory delegation and promotive voice behavior, results confirmed the proposed relationship. Findings are consistent with previous studies that role of leadership serves not only as a precursor for the generation of cognitive actors but also triggers voice behavior of employee (Ashford et al., 2009). Thus supervisory delegation as a form of leadership triggers felt obligation among employees for constructive changes within the organization. The felt obligation for constructive change further ignites the need for employee engagement in voice behavior, i.e. promotive voice behavior. As far as mediation of felt obligation for constructive change is concerned, when employees are delegated, they are more obligated for constructive improvement of the workplace which in turn leads to engagement of employee more engaging in promotive voice behavior. Promotive voice behavior is raising concern for improved organizational functioning. When the employees are more obligated because of more empowerment through delegation, they are more likely to engage in promotive voice behavior.

This study has not supported the role of felt obligation for constructive change as a mediatory mechanism between supervisory delegation and prohibitive voice behavior. There may be various reasons for this absence of mediation of felt obligation for constructive change when there is a direct relationship between not only supervisory delegation and prohibitive voice behavior as well as felt obligation for constructive change and prohibitive voice behavior. One reason may be is

that when employees are trusted through delegation, they are more obligated for constructive suggestions. Thus they do not engage in prohibitive voice behavior because that has the potential to disturb the relationship with senior management. Prohibitive voice is raising concerns about unhealthy work practices and policies being implemented by top management. When employees are delegated, they may feel obligated for constructive suggestion by engaging in promotive voice but not in prohibitive voice by reciprocating that mutual trust environment that was created by felt obligation. People in Asian context are more concerned about harmony and quality relationships building with colleagues and senior members (Triandis, 1995; Hofstede, 1980; Schwartz & Bardi, 2001) thus less engaging in prohibitive voice behavior by not challenging the status quo. They feel more obligated to remain aligned with others.

5.1.2.5 Hypothesis 13 Core Self Evaluation and Emotion Regulation

Results of the study support the hypothesis that core self-evaluation has its role in the prediction of emotion regulation of employees. People high on core self-evaluation develop and regulate their own emotions as well as they help others being more confident in nature. At the same time, employees with lower core self-evaluation are comparatively less likely to regulate their own emotions as well as being less confident and less helping to others. Thus consequently, people with higher core self-evaluation are more likely to express their emotions over pleasant events and speak about unpleasant events. Results of the study support the role of core self-evaluation for prediction emotion regulation among employees and then the underlying mechanism of emotion regulation between core self-evaluation and both types of voices, i.e. promotive voice behavior and prohibitive voice behavior.

5.1.2.6 Hypothesis 14 and 15 Emotion Regulation and Employee Voice Behavior

Whereas taking the role of emotion regulation for predicting promotive and prohibitive voice behavior has also been explored. Findings support that emotion regulation of employees helps them to engage in voice behavior. i.e. promotive

and prohibitive voice behavior. Engagement in voice behavior is triggered and behaviorally active by the self-regulation of emotions of employees (Zimmerman, 2001). Employees with less emotional regulation prefer to remain silent on unpleasant tasks in the organization. The processes and outcomes of emotion regulation not only depends upon self but also on the evaluation of goal (Trommsdorff & Rothbaum, 2008). As far as mediation of emotion regulation between core self-evaluation and both types of voice, (i.e. promotive voice behavior and prohibitive voice behavior), hypotheses were supported.

5.1.2.7 Hypothesis 16 and 17 Mediation of Emotion Regulation between Core Self Evaluation Employee Voice Behavior

Employees attempt to manage their behavioral and emotional responses through emotional regulation emotional (Trommsdorff & Rothbaum, 2008). Role of emotion regulation has also been found linked to the achievement of personal goal emotional (Trommsdorff & Rothbaum, 2008). Results of the study support the hypothesis that core self-evaluation has its role in the prediction of emotion regulation of employees. People high on core self-evaluation develop and regulate their own emotions as well as they help others being more confident in nature. Thus consequently, people with higher core self-evaluation are more likely to express their emotions over pleasant events and speak about unpleasant events. People with higher core self-evaluation are more aware of their confidence among themselves. Employees with higher core self-evaluation thus have the potential to regulate their own emotions because they firmly believe about their potential. Core self-evaluation itself is composed of higher-order traits like self-esteem, self-efficacy, locus of control and higher core self-evaluation indicates higher emotional stability of an individual (Aree, Walumbwa, Mondejar & Chu, 2013).

5.1.2.8 Hypothesis 18. Supervisory Delegation and Emotion Regulation

It was hypothesized that supervisory delegation in the organization helps employees to regulate their emotions. At the same time, the role of emotion regulation as

a mediatory mechanism between supervisory delegation and both types of voice behavior was also proposed. Findings of the study supported the hypothesis. It was identified about emotion regulation by Soric et al. (2013) that it has five types. So emotion regulation consists of situation selection, situation modification, attention deployment, and change of cognitions and finally, modulation of responses.

These modulations of responses can be further categorized as behavioral, experiential and physiological. So employees evaluate the environment where they perceive higher supervisory delegation, they develop their cognitions and regulates their emotions stepping towards voice behavior. Gross (2002) indicated that one of the critical characteristics of emotion regulation is behavioral in nature and voice is a behavior itself.

5.1.2.9 Hypothesis 19 and 20. Mediation of Emotion Regulation between Supervisory Delegation and Voice Behavior

Emotion regulation is an underlying mechanism between supervisory delegation and promotive voice behavior, and this has been supported through findings. Emotions may alter depending upon antecedents as well as outcomes. So mediation of emotion regulation between supervisory delegation and prohibitive voice behavior has not been supported. This may be because that emotion regulation tends to enhance positive emotional experiences as well as its potential to dampen the negative emotional experiences (Soric, Penezic & Buric, 2013). Thus engaging in prohibitive voice behavior through supervisory delegation by the mediation of emotion regulation, it is possible that employees might have evaluated the trust of their supervisor upon them through delegation. This evaluation of trust and delegation might help employees to regulate their emotions to engage in promotive voice behavior which looks favorable to managers who delegated and employees consciously withhold engagement in prohibitive voice behavior which may look unpleasant to managers who delegated and showed trust to their subordinates. That is why emotion regulation has not mediated between supervisory delegation and prohibitive voice behavior.

5.1.3 Research Question 3: What is the Impact of Employees' Proactive Behavior i.e. Voice Behavior in Generating the Perception of Managerial Hatred, Perceived Inclusion, and Perceived Exclusion?

Voice behavior as consisting of the potential of challenging the status quo (LePine & Van Dyne, 2001; Warren, 2003) may hamper the relationships with colleagues and seniors. An individual's voice behavior results from the process of the problematical situation analyses and coming up with the solution-oriented suggestion. If resultant suggestion, i.e. voice behavior is interpreted as a complaint or criticism, it may hamper the relationships and may build negative impressions of employees (Stamper & Van Dyne, 2001).

People high with proactive tendencies try to find out opportunities around them, and they always attempt to use those opportunities to achieve their goals (Crant, 2000; Bateman & Crant, 1993). Bateman and Crant (1993) further extend about proactive individuals that they try to influence their present situation. Voice behavior has been the focus of many researchers nowadays, and many antecedents responsible for voice behavior has been explored (Morrison, 2011). Despite these various antecedents, the underlying mechanism responsible for voice behavior, there is still little known about the outcomes of voice behavior (Jung, 2014), more specifically, how voice behavior influences the perpetrator and the victim.

5.1.3.1 Hypothesis 21 and 22 Voice Behavior and Managerial Hatred

Voice behavior of employee's results in various consequences for employees. It was proposed that there is a negative relationship between promotive voice and managerial hatred and positive relationship between prohibitive voice and managerial hatred. Results support the hypothesis, and it is consistent with existing studies on voice behavior. As promotive voice is raise of concern for improved organizational functioning and prohibitive voice is raise of concern for unhealthy practices, procedures and policies which have the potential to harm the organization. Thus when managers perceive the intent of employees as constructive, i.e. engagement

in promotive voice, managers may not show or not engage in hatred towards them. Whereas when managers may perceive that intent behind engagement in voice behavior is malicious or one may consider it as a kind of criticism, i.e. prohibitive voice behavior, managers may engage in hatred towards them. As prohibitive voice is about unhealthy practices, policies and procedures and policies and rules and regulations are developed at senior levels and then flows down to next subsequent levels. So when voice is raised directly about these policies, managers may consider it as a direct threat or direct criticism from employees working at lower levels to them. Thus employees engaging in prohibitive voice may become a victim of more managerial hatred.

As voice is usually raised against wrong practices, policies and procedures of the organization, thus have the potential to challenge the status quo. At the same time, policies and procedures of doing things are usually formulated at upper levels and then transferred to the next subsequent levels. Thus voice raised either promotive or prohibitive, both may influence the recipient's reaction .i.e. senior management, colleagues etc. Talking about the direct relationship between promotive voice and perceived managerial hatred, it was found that there is a negative relationship. More the occurrence of promotive voice, less is the perceived managerial hatred. As promotive voice behavior is raising the voice for improved organizational functioning, there are lesser chances that it would be considered as unfavorable by others as it is less directly targeting others at the workplace. Instead, the person engaged in promotive voice behavior may be considered as a more responsible soldier for the organization. As the person is more concerned about improved organizational functioning so that employees may be compensated for their inputs for the organization through their suggestions and managers may feel obligated to reciprocate to their constructive suggestions (Podsakoff et al., 2000; Van Dyne & LePine, 1998).

As far as the relationship between prohibitive voice behavior and managerial hatred is concerned, it was proposed to be more positive and significant. Results approved the notion as the more an employee is engaged in prohibitive voice behavior, the more he had to face hatred from his manager. Prohibitive voice is

considered comparatively more complaining in nature, and it points out the flaws in existing ways of doing things as well as it prohibits the wrong policies and procedures to be practised. Thus it has more potential to be perceived as unfavorable by managers. Prohibitive voice raiser may be perceived as a potential problem creator. This notion is consistent with previous studies that people engaging in voice may be considered as troublemakers because nature of voice damage the interpersonal relationships with the person receiving voice and even it may sometimes result in unfavorable performance evaluations (Milliken, Morrison, & Hewlin, 2003; Morrison & Milliken, 2000).

5.1.3.2 Hypothesis 23 and Hypothesis 24 Voice Behavior and Perceived Workplace Inclusion

Talking about outcomes of voice behavior for employees in the form of perceived workplace inclusion has also been tested. It was proposed that there is a positive relationship between promotive voice and perceived workplace inclusion and negative relationship between prohibitive voice and perceived workplace inclusion. The results have supported the positive relationship between promotive voice and perceived workplace inclusion, and it is consistent with previous studies. When employees perceive that they would be interpreted positively by engagement in voice, i.e. promotive voice and they would not be misunderstood by others, i.e. seniors, colleagues and subordinates, it would encourage and motivate them to engage in promotive voice behavior. It is perceived that the promotive voice is healthy for improved organizational functioning. It is consistent with previous findings that others response to voice behavior depends upon the nature of the voice (Burris, 2012).

When the voice is considered more pro-social in nature and characterized as having lesser negative characteristics, it tends to receive more positive appraisal by managers (Grant et al., 2009). Similarly, some other researchers are also of the view that positive outcomes for voice behavior only emerge when it is considered as helping in nature and not offending (Whiting, Podsakoff, & Pierce, 2008; Mackenzie, Podsakoff, & Podsakoff, 2011). It has been reported that voice receivers may

respond positively to voice in many cases and it may be considered as constructive for improving the effectiveness of organization and voice is considered as an indication of positive behavior towards workplace (Podsakoff et al., 2009; Jung, 2014). Consequently, senior management may consider it as their obligation to appreciate and payback employee's constructive inputs through including them into in-groups resulting in perceived workplace inclusion.

As far as a negative relationship between prohibitive voice and perceived workplace inclusion is concerned, it was not supported by results. There may be many reasons as one reason can be that when employees engage in prohibitive voice behavior, they are actually pointing out about unhealthy policies and regulations that are collectively unhealthy about overall organizational functioning. Everyone at the workplace, i.e. colleagues and subordinates, are being influenced by those unhealthy practices being implemented in the organization.

So when one is engaging in prohibitive voice behavior, others at the workplace may look at that individual as an opportunity raising the voice for the benefit of others. So engagement in prohibitive voice may help in turn for perceived workplace inclusion. That's why the proposed negative relationship between prohibitive voice behavior and perceived workplace inclusion has not been supported. Voice behavior that is more challenging in nature (i.e. prohibitive voice behavior) experience low appraisal by the managers (Burris, 2012, Jung, 2014).

Voice behavior is not welcomed in many cases by voice recipients because it has the potential to challenge something to which they are currently satisfied with. Similarly, it may also be considered as unfavorable feedback by employees towards current policies and procedures (Morrison & Milliken, 2000). Voice behavior of employees is perceived as a kind of offence and triggered by some personal interest.

Voice behavior of employees is resisted by senior management when it is directed towards them, resulting in enhanced perceived exclusion. Similarly, when voice behavior is directed towards colleagues, coworkers, peers and subordinates, it is perceived as a complaint, less valuable and detrimental to existing unity within the organization, causing increased exclusion.

5.1.3.3 Hypothesis 25 and Hypothesis 26 Voice Behavior and Perceived Workplace Exclusion

Perceived workplace exclusion as an outcome of voice behavior was also proposed. It was proposed that there is a negative relationship between promotive voice behavior and perceived workplace exclusion, and there is a positive relationship between prohibitive voice and perceived workplace exclusion. It was found through the results that the negative relationship between promotive voice and perceived workplace exclusion has not been supported. There can be various reasons. Both types of voice are constructive in nature (Liang, Farh & Farh, 2012). However, how promotive voice is interpreted, matters for the outcome. It was assumed that a more an employee is engaging in promotive voice behavior, less would be perceived exclusion.

However, the intent behind engagement in promotive voice is not always interpreted constructive and may be taken as a complaint that's why the hypothesis has not been supported. As far as the positive relationship between prohibitive voice behavior and perceived workplace exclusion is concerned, the hypothesis was supported. It seems logical that prohibitive voice behavior which is a raise of concern for policies and practices which are unhealthy for the workplace, would not be welcomed by others and eventually would result in enhanced exclusion from others. Both types of voices, i.e. promotive and prohibitive are constructive in nature and are considered crucial for the effective functioning of the organization (Liang, Farh, & Farh, 2012; Xie, DingLing, Mo & Luan, 2015). But the intention to engage in any type depends upon required energy of individual for engagement in voice behavior. The prohibitive voice has the potential to damage the relationship with colleagues, seniors and subordinates. At the same time, promotive voice is a raise of concern about the improvement of organizational functioning and practices. This is also because of the power associated with upper management; there is more risk involved when employees engage in prohibitive voice behavior. When employees trust that the voice they are raising is about improvement in practices, i.e. promotive, risk-taking behavior may promote their engagement in voice behavior, resulting in lesser perceived hatred of manager, lesser perceived exclusion

from colleagues and improved inclusion from colleagues, seniors and subordinates. If workers consider that speaking up has a heavy cost associated, they may withhold their viewpoint by not engaging in voice behavior (Cheng, Chang, Kuo, & Lu, 2014).

Cheng et al. (2014) discussed interpersonal risk associated with voice. Thus it may result in specific outcomes for the employee in the form of managerial hatred, and perceive exclusion from coworkers. Employees engage in voice behavior only when they consider that engagement in voice behavior is safe and would not result in adverse outcomes (Ho, 2017). Employees engage in voice behavior when they perceive that their behavior would result in significant outcomes (Elsaied, 2018).

5.1.4 Research Question 4: What is the Role of Work Context i.e. Voice Climate as a Moderator for the Relationship between Cognitive Motivational State and Affect related Process i.e. Felt Obligation for Constructive Change, Emotion Regulation and Proactive Behavior i.e. both Dimensions of Voice Behavior?

Besides various dispositional and managerial factors, some contextual factors are also responsible for the prediction of employees' engagement in voice behavior (Jung, 2014). Some of the contextual factors such as work environment, work characteristics and support from group members as well as workplace climate are crucial for enhancing employee voice (Tangirala & Ramanujam, 2008; LePine & Van Dyne, 1998; Bowen & Blackmon, 2003; Morrison & Milliken, 2000). Voice climate is considered as the shared perception of employees regarding what psychologically matters at the workplace (Morrison & Milliken, 2000). Voice climate is responsible for the prediction of voice at group level and not only at the individual level (Jung, 2014).

5.1.4.1 Hypothesis 27 and Hypothesis 28 Voice Climate as Moderator between Felt Obligation for Constructive Change and Voice Behavior

This study has confirmed that voice climate moderated the relationship significantly between felt obligation for constructive change and promotive voice behavior as promotive voice behavior is raising concern for improved organizational functioning and its policies. So voice climate enhances the environment for this specific type of voice. When employees are experiencing felt obligation for constructive suggestions for the organization, shared perception regarding improved functioning, policies and procedures is multiplied by voice climate.

The environment at the workplace affects an employee's engagement in voice behavior (Cheng, Chang, Kuo, & Lu, 2014). Existing studies support the notion that employees are more likely to engage in voice behavior when they get support from others. (Miceli et al., 2008). Employees are more likely to engage in voice behavior when the working environment is supportive and conducive for new ideas (Elsaied, 2018). If the environment is supportive, employees perceive that there would be less reaction of coworkers to voice raised. Instead, the voice would be considered as constructive and positive for the effective functioning of the workplace. Colleagues at the workplace impact the tendency of promoting felt obligation for constructive change which then fosters employees to engage in voice behavior (Xie, DingLing, Mo & Luan, 2015).

Whereas talking about types of voice behavior, where promotive voice behavior is presenting constructive suggestions about status quo improvement, and prohibitive voice is information about errors at workplace approaches which may significantly impact the overall performance of the organization. Thus this colleague support in the form of voice climate may differently influence the relationship of felt obligation for constructive change and both types of voice, i.e. promotive voice and prohibitive voice.

Voice climate has not moderated the relationship between felt obligation for constructive change and prohibitive voice behavior. Morrison and Milliken (2000)

argued that employees perceive that voice is detrimental or engaging in voice is not worth the effort; they may not engage in voice. However, the study has rejected any of the possibility regarding moderation of voice climate for felt obligation for constructive change and prohibitive voice behavior. Voice climate has not moderated the said relationship.

5.1.4.2 Hypothesis 29 and Hypothesis 30 Voice Climate as Moderator between Emotion Regulation and Voice Behavior

Voice climate has significantly moderated the relationship between emotion regulation and promotive voice behavior. The relationship was also significant for the moderation of voice climate between emotion regulation and prohibitive voice behavior. Findings were consistent with previous studies that voice climate is an essential predictor of voice behaviors (Morrison et al., 2011).

5.1.5 Research Question 5: Whether Perceived Risk Moderate the Relationship between Proactive Behaviors i.e. Voice Behavior and its Outcomes

Perceived risk as the moderator for the relationship between voice behavior and its outcomes was tested as the appropriateness of behavior between voice behavior and its desirable and undesirable outcomes. Previous research opinionated that it is not only the voice behavior and the voice recipient, but it is the situation too, that influences this relationship (Whiting, Maynes, Podsakoff, & Podsakoff, 2012). At the same time, Jung (2014) postulated about the need for the research for the underlying mechanism between the occurrence of voice and possible reactions to it.

Most of the previous studies are unsuccessful at understanding these two cores, which are understanding voice behavior utility and appraising the concerned utility by others (Jung, 2014). Voice behavior may be constructive in nature aimed at

improving organizational practices yet may be taken as challenging and disruptive because of the potential of creating conflicts with others.

Role of the perceived risk of employees engaging in voice behavior was studied as a moderator between both types of voice and their outcomes. When people may fear regarding repercussions of voice engagement, and it may influence their intention to engage in voice behavior (Jung, 2014). Associated fear is actually stemming from the assessment of risk (Detert & Edmonson, 2005).

5.1.5.1 Hypothesis 31 and Hypothesis 32 Perceived Risk as the Moderator between Voice Behavior and Managerial Hatred

As far as hypothesis is concerned that the negative relationship between promotive voice behavior and managerial hatred would be strengthened when the assessment of perceived risk is high. Increase in estimate proved that perceived risk strengthened the proposed relationship. Detert and Edmondson (2005) state that people usually are afraid of challenging others because of hierarchies. Raising concerns with and against senior management can be threatening (Detert & Trevino, 2010). Challenging others is an outcome of the assessment of perceived risk (Kish-Gephart et al., 2009). In a culture like Pakistan, where there are ingrained hierarchies, with more power distance, employees are more afraid of raising concerns.

Results of the study support the notion and relationship between promotive voice behavior and managerial hatred was stronger when perceived risk was introduced as moderator for the said relationship. The direction was also negative, which was proposed and expected meaning that more engagement in promotive voice behavior resulted in lesser managerial hatred. So when perceived risk is introduced as moderator for the said relationship, it antagonized the relationship between prohibitive voice and managerial hatred. Means when employees perceived that engaging in prohibitive voice results in increased managerial hatred resulting in unfavorable consequences, the said perception of risk antagonized the previously positive relationship between prohibitive voice and managerial hatred.

5.1.5.2 Hypothesis 33 and Hypothesis 34 Perceived Risk as the Moderator between Voice Behavior and Perceived Workplace Inclusion

Perceived risk was taken as a moderator between promotive voice behavior and perceived workplace inclusion; moderation was found significant. When the perception of perceived risk would be high, employees engaging in promotive voice behavior would be more included by others. Estimate value although decreased for the relationship between promotive voice behavior and perceived workplace inclusion. Employees have to see their interactions with seniors as well as they have to look at the interactions with others at the same level. When employees are afraid of damaging the relationship with others employees are afraid of social isolation, it means, they can assess the intensity if the risk of damaging relationships, resulting in an increased perception of risk (Bowen & Blackmon, 2003). At the same time, our findings were found consistent with the notion of Jung (2014) that engaging in voice behavior may result in constructive as well as destructive conflicting reaction.

Moderation of perceived risk for the relationship between promotive voice and perceived workplace inclusion was also supported through the results. Although estimate weight decreased, results proved that engagement in promotive voice increases perceived workplace inclusion from colleagues, subordinates and seniors. Whereas the relationship between prohibitive voice and perceived workplace inclusion was not moderated through perceived risk

5.1.5.3 Hypothesis 35 and Hypothesis 36 Role of Perceived Risk as the Moderator between Voice Behavior and Perceived Workplace Exclusion

Relationship between promotive voice and perceived workplace exclusion was moderated and strengthened by the perceived risk of employees. It means that higher engagement in promotive voice resulted in lesser exclusion from others, i.e. seniors, subordinates and colleagues at the workplace. Results of the study regarding the

relationship between prohibitive voice behavior and its outcomes through moderation of perceived risk support the existing studies (Son, 2018; Ng and Feldman, 2013; Gao et al., 2011; Premeaux & Bedeian, 2003).

As discussed above, that prohibitive voice has the potential of damaging relationships with others at the workplace. As far as the relationship between prohibitive voice and perceived workplace exclusion is concerned, it was previously positive, but when perceived risk is being introduced as moderator, it antagonized the relationship. Its because employees can perceive possible repercussions of engaging in prohibitive voice, Culture like Pakistan which is high on power distance, employees can foresee the outcomes of engaging in prohibitive voice.

Prohibitive voice is raising concern about unhealthy practices at workplace and procedures. Practices and procedures are usually implemented and flow from senior management, thus pointing out flaws about them may result in poor relationships with them. Employees may have to face unfavorable evaluation as well as criticism and negative feedback from colleagues resulting in increased exclusion. Thus the perception of risk moderated this relationship by antagonizing the previously positive relationship between prohibitive voice and perceived exclusion.

Previous studies support the notion that employees evaluate the circumstances by comparing the pros and cons of engaging in any behavior (Liu, Yin & Li, 2013; Morrison & Rothman, 2009; Detert & Burris, 2007). When employees perceive that engagement in any specific behavior may result in adverse outcomes, they may refrain themselves from engaging in that behavior (Morrison, 2011; Liu, Yin & Li, 2013, 2013; Detert & Burris, 2007). Engaging in voice behavior may be taken as criticizer by others at the workplace (Miceli, Near, & Dworkin, 2008; Liu, Yin & Li, 2013). Engaging in voice behavior may result in loss of support from others as well as in low evaluation from managers (Ashford, Sutcliffe, & Christianson, 2009) as scholars consider voice behavior as risky and unsafe behavior (Takeuchi, Chen, & Cheung, 2012). Employees may turn defensive and become afraid of engaging in voice behavior. Whereas when there is lesser risk associated with voice behavior, it may motivate employees to engage in voice behavior.

5.2 Theoretical Implications

Findings of the current study contribute to the theory of proactive motivation and employee's voice behavior in several ways. Firstly, the current study confirmed the direct relationship between situational and dispositional antecedents to proactive behavior. Situational Antecedent studied was supervisory delegation, and dispositional antecedent was an employee's core self-evaluation. Impact of these constructs was related to proactive behavior, i.e. voice behavior of employees. Thus study confirms that situational and dispositional factors are critical for fostering proactive behavior (Tangirala et al., 2013). The findings of this study are consistent to the existing studies on proactive behavior theory that dispositional and situational antecedents fosters employees engagement in voice behavior (Aryee, Walumbwa, Mondejar, & Chu, 2017; Wu, Parker, Wu & Lee, 2018).

Secondly, the present study explored the relationship between situational and dispositional antecedents to an employee's felt obligation for constructive change which is also supporting the proactive motivation theory. The findings of the study support the idea that when employees are delegated responsibilities and involved in decision-making processes, they perceive higher obligation for constructive change towards the organization. It is more likely proactive goal generation state of proactive behavior theory (Parker, Bindl & Strauss, 2010) where employees try to improve the internal working environment through problem-solving and improving working conditions. They find it as a reciprocal process and considers their obligation to pay back to the organization. The study validates that when workers are valued at the workplace through delegation of tasks and involvement in decision-making processes. Thus employees find it reciprocal to engage in suggestion oriented behavior through felt obligation for constructive change. Whereas higher core self-evaluation of an individual also fosters him to feel more obligated towards the workplace. It is because of personality characteristics packed under the domain of CSE intriguing felt obligation for constructive change.

Thirdly, the present study also contributes towards the relationship between dispositional and situational antecedents with emotion regulation, i.e. affect the related

state of the employee. Emotion regulation is a proactive goal striving state of employees where they tend to bring change in themselves and the situation (Bindle & Parker, 2010). Findings of the study support the notion of proactive behavior theory (Parker, Bindl & Strauss, 2010). Emotion regulation provides employees with a state of 'energized to do' condition for engaging in voice behavior.

Fourthly, the study has contributed towards the role of voice climate as moderator as suggested in the theory of proactive motivation. The findings support the notion that organizational climate can foster employees views about engagement in any proactive behavior, i.e. voice behavior. Findings of the current study are in congruence with existing studies on voice behavior. Voice climate is a psychological mechanism that creates an environment where employees feel confident for their ability to engage in voice behavior, feels it safe to raise the concern (Edmondson, 2004; Lio et al., 2012). The findings also support the theory of proactive motivation (Parker, Bindl & Strauss, 2010).

Fifthly, the current study has contributed towards the favorable and unfavorable outcomes of voice behavior. Lots of existing have investigated the antecedents of voice behavior, but literature investigating the outcomes of voice behavior is still lacking. Voice behavior is considered as a challenge to the status quo. It is not considered as socially desirable. Due to the undesirable nature, employees have to explore the consequences before engaging in voice behavior consciously. The study has contributed to the literature by studying the outcome of voice behavior in the form of perceived managerial hatred, perceived workplace inclusion and perceived workplace exclusion.

5.3 Managerial Implications

Organizations nowadays have to face uncertainty, environmental complexity and challenges due to unexpected changes in the external and internal environment. Proactive behaviors by employees are considered crucial for successfully responding to unexpected events and workplace issues. Employee's proactive voice behavior thus plays an essential role for improvement of organizational practices, innovative

work behavior and pointing out flaws in organizations (Jiang, Li & Gollan, 2017; Liang, Farh & Farh, 2012; Aryee et al., 2017; Zhou, Feng & Liu, 2017). Various practices are being studied, which are also used for the generation of voice behavior of employees. These managerial practices have their role for generating voice behavior and may involve understanding and polishing individual's dispositional traits as well as the provision of an environment that help employees to engage in voice behavior.

Findings of the present study have several suggestions for managers for not the only telecommunication sector but also for other service industries. Numerous studies suggested that employee voice behavior is essential for better organizational functioning, sustainability, detection of errors and organizational survival (Parker & Collins, 2010; Aryee, Walumbwa, Mondejar & Chu, 2013). It was found that dispositional trait, i.e. core self-evaluation of an individual helps him to rate himself well and enables him to stand against wrong practices of the organization. Voice behavior of employees, although constructive in nature is not always welcomed by others at the workplace. It has a risky nature because it inclines to challenge the status quo. Thus core self-evaluation provides the required energy to boost up employees strength to engage in voice behavior. CSE helps employees to sustain in case employees are criticized for their effort to engage in voice behavior.

The current study recommends that managers at the workplace can cultivate an air that is favorable for employees to be more assured for engaging in voice behavior for better organizational functioning. Managers are accepting employees worth and expertise when they delegate power and authority to their subordinates. Managers find ways to appreciate the talent of employees by the delegation of power. Delegation is actually the process of employee empowerment which enables employees to perform independently. Thus supervisory delegation enables employees to look at the organization by a sharp eye and point out the things that can help the workplace to work effectively. Thus employees' can be motivated to engage in voice behavior by immediate bosses themselves by a delegation of authority. Voice behavior is risky, requires energy and not always approved by authorities. But when managers delegate, they feel themselves eased.

Felt obligation for constructive change can be ignited through supervisory delegation. When employees are delegated, they are actually more motivated to act responsible and meaningful. They feel obligated to pay back to the workplace in which they have been trusted. Employees are given a quality relationship through supervisory delegation where they can exercise authority, challenging tasks and support and trust for employee's behavior which in turn enables them not only to engage in the felt obligation for constructive change but this underlying mechanism also support the generation of voice.

Organizations need to cultivate an environment which is high on supervisory delegation. At the same time, it is also crucial for organizations to arrange training programs for managers so that may enable themselves for delegation of tasks to the next subsequent levels. The environment would enable employees to feel confident of their ideas and propensity of engagement in voice behavior. The delegation climate would also enable managers to work with and listen to their employees. This may also increase the interaction between manager and subordinate and decrease the communication gap between both.

Similarly, an environment which is high on expectation for voice, i.e. voice climate nourishes voice behavior of employees. Voice behavior has the potential of damaging the relationship with others, thus risky in nature. Employees may always perceive a psychological threat to engagement in voice behavior. But when there is an environment which is high on expectations for voice, i.e. voice climate, employees feel secure to engage in voice behavior. It provides them with a psychological state that is positive and conducive for the generation of voice behavior. It builds employees confidence by looking at others of the same level who are also engaging in voice behavior and are not being punished for criticizing unhealthy policies and practices. A culture high on collectivism promotes any behavior where employees are interwoven socially.

The current study has implications for managers of public as well as private organizations striving for growth and excellence. Findings support that top management should cultivate a culture where employees perceive that they influence the effectiveness of the workplace, and that is through their voice behavior. Top

management needs to demonstrate confidence in the worth and expertise of their employees. Top management needs to make their subordinate perceive that their constructive suggestions via voice behavior are being noticed and given importance. When employees perceive that their own voice, as well as effort of others for engagement in voice, is not being ridiculed or reprimanded, this will increase the tendency of engagement in voice behavior.

Organizations are facing extreme rivalry, challenges and competition. It has also become challenging for the organization to reward financially and economically to employees for their efforts (Lee, Wang & Liu, 2017). So management should use an environment which helps to cultivate motivation for employees. An environment where employees feel empowered, given chances for decision making, increased inclusion by others, they feel thriving at work. So managers should fabricate the workplace in an autonomous way for employees with lesser risk involved for participation in decision making.

Employees consider their job as more meaningful and purposeful when they are encouraged to give suggestions and speak up. It enhances employees perception that proactive work environment gives them better opportunities to exhibit their role at the workplace, (Bandura, 1989). Workplace voice climate boosts employees' confidence that their performance has an impact on the organization (Morrison, Smith & Kamdar, 2011).

5.4 Strengths of the Study

This study incorporated both dimensions of voice behavior, i.e., promotive voice behavior and prohibitive voice behavior as outcomes of CSE and supervisory delegation and with the mediation of FOCC and emotion regulation as mediators with both dimensions of voice behavior. Desirable and undesirable consequences of both dimensions of voice behavior were studied in the form of perceived managerial hatred, perceived workplace inclusion and perceived workplace exclusion. The study investigated the relationships based on proactive behavior theory (Parker, Bindl & Strauss, 2010).

The current study has several methodological strengths that enhance the generalizability of the results. Firstly, responses were taken from distinct sources. Responses on employee voice behavior were taken from the immediate supervisor, and responses on other predictors i.e. core self-evaluation, supervisory delegation, felt obligation for constructive change, emotion regulation and outcomes i.e. managerial hatred, perceived workplace inclusion and perceived workplace exclusion were obtained from employees themselves. Supervisors were asked to rate their employees on voice behavior because they can better assess their employees level of engaging in a specific behavior.

Employees felt obligation for constructive change is a psychological state, and emotion regulation is his affect related state. So according to Conway and Lance, (2010), it is suggested to collect data on these psychological states from employees themselves. Responses on the dispositional trait, i.e. core self-evaluation and how much employees perceive delegation by managers were collected from employees themselves. Similarly, data on outcome were also collected from employees themselves because they can more accurately assess the outcome they experience as a result of their behavior, i.e. voice behavior.

Secondly, another strength of the current study is the use of time lags between collections of responses. Time lag method decreases the biases related to a single source and common method (Podsakoff, MacKenzie, Lee & Podsakoff, 2003).

5.5 Limitations

The study has certain limitations. The current study tested the theory of proactive motivation, i.e. western-based theory, with paradigms being used in the Asian context. Thus this may reduce the external validity and generalizability of the study findings. Similarly, the sample was also limited to telecommunication sector of Pakistan only. Future researchers need to replicate the study in a context distinct from Pakistan. Secondly, considering cultural differences, as Pakistan is high on power distance as well as high on superficial harmony, research on employee voice behavior needs to be studied with more cautiousness.

5.6 Future Directions

The present study has examined direct, mediating and moderating effects between constructs. Future studies should explore other cognitive motivational states and affect related processes as mediatory mechanisms for prediction of voice behavior. At the same time, other potential pleasant and unpleasant consequences for employee voice behavior should be highlighted. Using and making the base of proactive motivation theory, future studies should consider other personality characteristics such as achievement orientation, duty orientation, risk taking and self-monitoring as employee voice behavior require personal effort and confidence. Leader specific predictors for promoting employee voice behavior would be another addition to the proactive motivation theory. Future researchers may take leaders dispositional characteristics as well as leaders types that may have a role on employee voice behavior such as laissez-faire leadership style, proactive leadership, safety specific leadership and most importantly role of responsible leadership.

Furthermore, dimensions of voice behavior can be linked with employee innovative behavior and organizational effectiveness too. As researchers have been emphasizing importance of flexible and open thinking for fostering innovation and creativity (George, 2007). Both dimensions of voice behaviour needs to be studied considering the both desirable and undesirable outcomes for organization and voice raiser. Especially employee wellbeing needs special attention of future scholars as the possible outcome to be influenced due to voice engagement.

Role of organizational climate needs further attention whether it is voice climate, inclusive climate or safety climate. Another future avenue to be studied can be the positive interpersonal relations between leaders and followers as an essential role in enhancing voice behaviour. Taking proactive behaviour theory, it is suggested to study some other contextual variables as moderators between antecedents and voice behaviour specifically context specific. Additionally factors related to appropriateness of behaviour can be studies as well between voice behaviour and its outcomes. Due to its importance for organizations, future researchers need to identify other factors that may constrain or expedite the expressions of voice.

5.7 Conclusion

Employee voice behavior is a complex yet very useful and crucial phenomenon, indeed. It is concluded that findings of this study are informative, and it uses proactive behavior theory as overarching model to explore the role of individual characteristics of voice raiser in the form of core self-evaluation and leader specific characteristic in the form of supervisory delegation to promote employee voice behaviour. Cognitive motivational state and affect related processes in the form of felt obligation for constructive change and emotion regulation were taken as mediatory mechanism between antecedents i.e. CSE and supervisory delegation and outcomes that are promotive and prohibitive voice behavior. Context specific variable that is the voice climate was taken as moderator as per the proactive behaviour theory (Parker et al, 2010).

The role of perceived risk as the appropriateness of behaviour was assessed as moderator between voice behaviour and outcomes of both dimensions of voice behavior . Both dimensions of voice behaviour were also studied for providing insight into how these dimensions that are promotive voice behaviour and prohibitive voice behaviour are interpreted by managers and colleagues at workplace. So along with the organizational climate, perceived risk for voice is necessarily assessed by employees in any organizational context. This perceived risk for voice may vary again according to national and organizational culture. Future studies should not ignore the cultural context for expectation of voice from employees by supervisor. As culture like Pakistan, where voicing up by employees is not always encouraged and frowned upon because having high power distance orientation, perceived risk for both dimensions of voice behaviour i.e. promotive and prohibitive voice behaviour needs to be assessed. The promotive voice which is more future-oriented and attempts to make things better is considered constructive thus employees engaging in promotive voice behavior are more included, i.e. perceived workplace inclusion, less excluded i.e. perceived workplace exclusion and may face less unpleasant perception of managerial hatred. Prohibitive voice behavior, which is more past and present-oriented, attempts to bring attention to factors that could turn loss to organizational sustainability and it is often interpreted as “what should be.”

Thus it has more potential to challenge the status quo as most of the practices and policies are developed and shaped by senior management. Similarly people at workplace are accustomed to already prevalent practices and procedures and may resist prohibitive voice behavior. Consequently, it may be interpreted as less likely to be fruitful for organizational effectiveness. Thus employees' acceptance and rejection by others at a larger level mainly depends upon the type of voice behavior an employee engages. Because of challenging nature of prohibitive voice behavior, employees may be less included by others at workplace. As they may be considered as problem creators or complaint seekers. Organizations need to respond to uncertain environments with efficiency and effectiveness and this is not possible without the active involvement of employee's voice behavior. So in order to fully capitalize on the effects of voice behavior for making organization effective both dimensions of voice behavior need to be acknowledged by managers (Um-e-Rubbab & Naqvi, 2020). Along with this, importance of voice cannot be ignored, and nowadays more emphasis is being placed on "speaking up" to tackle competitive environment.

Bibliography

- Acquadro, C., Conway, K., Hareendran, A., Aaronson, N., & European Regulatory Issues and Quality of Life Assessment (ERIQA) Group. (2008). Literature review of methods to translate health-related quality of life questionnaires for use in multinational clinical trials. *Value in Health*, 11(3), 509-521.
- Agnihotri, N. (2017). Assessing Factors Influencing Employees' Voice Behavior in Organizations (Doctoral dissertation, *State University of New York at Albany*).
- Akkermans, J., & Tims, M. (2017). Crafting your career: How career competencies relate to career success via job crafting. *Applied Psychology*, 66(1), 168-195.
- Al-Jammal, H. R., Al-Khasawneh, A. L., & Hamadat, M. H. (2015). The impact of the delegation of authority on employees' performance at great Irbid municipality: case study. *International Journal of Human Resource Studies*, 5(3), 48-69.
- Alola UV, Avci T, Ozturen A. Organization sustainability through human resource capital: The impacts of supervisor incivility and self-efficacy. *Sustainability*. 2018 Aug;10(8):2610.
- Amabile, T. M. (1983). The social psychology of creativity: A componential conceptualization. *Journal of Personality and Social Psychology*, 45(2), 357.
- Anderson, J. G. (2004). The basic of structural equation model. web. ics. purdue.edu/ janders1/Soc681/Soc, 20681.
- Andersson, L. M., & Pearson, C. M. (1999). Tit for tat? The spiraling effect of incivility in the workplace. *Academy of Management Review*, 24(3), 452-471.

- Araya, M. A. (2015). The interactive effect of core self-evaluations and perceived organizational support in predicting work engagement.
- Argyris, C., & Schon, D. (1978). *Organizational learning: A theory of Action Approach*. Reading, MA: Addison Wesley.
- Aryee, S., Walumbwa, F., Mondejar, R., & Chu, C. (2013). Accounting for the influence of overall justice on job performance: Integrating self-determination and social exchange theories. *Journal of Management Studies*. <http://doi.org/q6b>
- Aryee, S., Walumbwa, F.O., Mondejar, R. and Chu, C.W. (2017), "Core self-evaluations and employee voice behavior: Test of a dual-motivational pathway," *Journal of Management*, Vol.43, pp.946-966.
- Ashford, S. J., & Black, J. S. 1996. Proactivity during organizational entry: The role of desire for control. *Journal of Applied Psychology*, 81: 199-214.
- Ashford, S. J., Sutcliffe, K. M., & Christianson, M. K. (2009). Speaking up and speaking out: The leadership dynamics of voice in organizations. *Voice and Silence in Organizations*, 175-202.
- Atkinson, L., Niccols, A., Paglia, A., Coolbear, J., Parker, K. C., Poulton, L., & Sitarenios, G. (2000). A Meta-Analysis of Time Between Maternal Sensitivity and Attachment Assessments: Implications For Internal Working Models In Infancy/Toddlerhood. *Journal of Social and Personal Relationships*, 17(6), 791-810.
- Attiq, S., Wahid, S., Javaid, N., & Kanwal, M. (2017). The Impact of Employees' Core Self-Evaluation Personality Trait, Management Support, Co-worker Support on Job Satisfaction, and Innovative Work Behaviour. *Pakistan Journal of Psychological Research*, 247-271.
- Avery, D. R., & Quiñones, M. A. (2002). Disentangling the effects of voice: the incremental roles of opportunity, behavior, and instrumentality in predicting procedural fairness. *Journal of Applied Psychology*, 87(1), 81.
- Babalola, M. T., Mawritz, M. B., Greenbaum, R. L., Ren, S., & Garba, O. A. (2021). Whatever it takes: How and when supervisor bottom-line mentality

- motivates employee contributions in the workplace. *Journal of Management*, 47(5), 1134-1154.
- Bandura, A. (1982). The assessment and predictive generality of self-percepts of efficacy. *Journal of Behavior Therapy and Experimental Psychiatry*, 13(3), 195-199.
- Bandura, A. (1986). The Explanatory and Predictive Scope of Self-Efficacy Theory. *Journal of Social and Clinical Psychology*, 4(3), 359-373.
- Bandura, A. (1989). Regulation of cognitive processes through perceived self-efficacy. *Developmental Psychology*, 25(5), 729.
- Bandura, A. (1994). Social cognitive theory and exercise of control over HIV infection. In Preventing AIDS (pp. 25-59). *Springer, Boston, MA*.
- Bandura, A., & Walters, R. H. (1977). Social learning theory (Vol. 1). *Englewood Cliffs, NJ: Prentice-hall*.
- Barrick, M. R., & Mount, M. K. (1991). The big five personality dimensions and job performance: a meta-analysis. *Personnel Psychology*, 44(1), 1-26.
- Bashshur, M. R., & Oc, B. (2015). When voice matters: A multilevel review of the impact of voice in organizations. *Journal of Management*, 41(5), 1530-1554.
- Bass, B. M. (1990). From Transactional To Transformational Leadership: Learning To Share The Vision. *Organizational Dynamics*. 18, 19-31. doi: 10.1016/0090-2616(90)90061-S.
- Bateman, T. S., & Crant, J. M. (1993). The proactive component of organizational behavior: A measure and correlates. *Journal of Organizational Behavior*, 14(2), 103-118.
- Baumeister, R. F. (1997). Esteem threat, self-regulatory breakdown, and emotional distress as factors in self-defeating behavior. *Review of General Psychology*, 1(2), 145-174.
- Baumeister, R. F., Campbell, J. D., Krueger, J. I., & Vohs, K. D. (2003). Does high self-esteem cause better performance, interpersonal success, happiness, or healthier lifestyles?. *Psychological Science in the Public*, 4(1), 1-44.

- Baumeister, R. F., DeWall, C. N., Ciarocco, N. J., & Twenge, J. M. (2005). Social exclusion impairs self-regulation. *Journal of Personality and Social Psychology, 88*(4), 589.
- Baumeister, R. F., Twenge, J. M., & Nuss, C. K. (2002). Effects of social exclusion on cognitive processes: anticipated aloneness reduces intelligent thought. *Journal of Personality and Social Psychology, 83*(4), 817.
- Berg, S. T. S., Grimstad, A., Škerlavaj, M., & Černe, M. (2017). Social and Economic Leader–Member Exchange And Employee Creative Behavior: The Role of Employee willingness To Take Risks and Emotional Carrying Capacity. *European Management Journal, 35*(5), 676-687.
- Bergeron, D. M., & Thompson, P. S. (2020). Speaking up at work: the role of perceived organizational support in explaining the relationship between perceptions of organizational politics and voice behavior. *The Journal of Applied Behavioral Science, 56*(2), 195-215.
- Bindl, U., & Parker, S. K. (2010). Proactive work behavior: Forward-thinking and change-oriented action in organizations (Vol. 2, pp. 567-598). *Washington, DC: American Psychological Association.*
- Blackhart, G. C., Nelson, B. C., Knowles, M. L., & Baumeister, R. F. (2009). Rejection Elicits Emotional Reactions But Neither Causes Immediate Distress Nor Lowers Self-Esteem: A Meta-Analytic Review Of 192 Studies On Social Exclusion. *Personality and Social Psychology Review, 13*(4), 269-309.
- Bohlmann, C., Rudolph, C. W., & Zacher, H. (2021). Effects of Proactive Behavior on Within-Day Changes in Occupational Well-Being: The Role of Organizational Tenure and Emotion Regulation Skills. *Occupational Health Science, 1-30.*
- Borman, W. C., & Motowidlo, S. J. (1997). Task performance and contextual performance: The meaning for personnel selection research. *Human Performance, 10*(2), 99-109.

- Bowen, F., & Blackmon, K. (2003). Spirals of silence: The dynamic effects of diversity on organizational voice. *Journal of Management Studies*, 40(6), 1393-1417.
- Brudholm, T. (2010). Hatred as an attitude. *Philosophical Papers*, 39(3), 289-313.
- Burris, E. R. (2012). The Risks And Rewards Of Speaking Up: Managerial Responses To Employee Voice. *Academy of Management Journal*, 55(4), 851-875.
- Burris, E. R., Detert, J. R., & Chiaburu, D. S. (2008). Quitting Before Leaving: The Mediating Effects Of Psychological Attachment And Detachment On Voice. *Journal of Applied Psychology*, 93(4), 912.
- Burris, E. R., Detert, J. R., & Romney, A. C. (2013). Speaking up vs. Being heard: The Disagreement Around And Outcomes Of Employee Voice. *Organization Science*, 24(1), 22-38.
- Burris, E. R., Rockmann, K. W., & Kimmons, Y. S. (2017). The Value of Voice to Managers: Employee Identification and the Content of Voice. *Academy of Management Journal*, 60(6), 2099-2125.
- Carapinha, R. (2013). Gender Differences In Perceived Organizational Exclusion-Inclusion: The Importance Of Status Closure And Role Investments. *Boston College*.
- Chamberlin, M. (2017). Exploring Supervisor Responses to Employees Who Share Bad News: Why and Under What Conditions are Messengers Shot? (*Doctoral Dissertation, Arizona State University*).
- Chamberlin, M., Newton, D. W., & Lepine, J. A. (2017). A Meta-Analysis of Voice and Its Promotive and Prohibitive Forms: Identification of Key Associations, Distinctions, and Future Research Directions. *Personnel Psychology*, 70(1), 11-71.
- Chang, C. H., Ferris, D. L., Johnson, R. E., Rosen, C. C., & Tan, J. A. (2012). Core self-evaluations: A review and evaluation of the literature. *Journal of Management*, 38(1), 81-128.

- Chen, G., Kirkman, B. L., Kanfer, R., Allen, D., & Rosen, B. (2007). A Multilevel Study of Leadership, Empowerment, And Performance In Teams. *Journal of Applied Psychology*, 92(2), 331.
- Chen, Z. X., & Aryee, S. (2007). Delegation and Employee Work Outcomes: An Examination of the Cultural Context Of Mediating Processes in China. *Academy of Management Journal*, 50(1), 226-238.
- Chen, L., Zhang, Z. D., & Jia, W. T. (2020). When and Why Leaders' Helping Behavior Promotes Employees' Thriving: Exploring the Role of Voice Behavior and Perceived Leader's Role Overload. *Frontiers in Psychology*, 11.
- Cheng, J., Chang, S. C., Kuo, J. H., & Lu, K. M. (2014). Social relations and voice behavior: The mediating role of psychological safety, *Criticism*, 32, 58.
- Cheuk, W. H., & Rosen, S. (1994). Validating a "spurning scale" for teachers. *Current Psychology*, 13(3), 241-247.
- Cheung, H. K., Liu, S. (2014). How Should We Speak: Comparing Effectiveness of Promotive and Prohibitive Voices. *Undergraduate Journal of Psychology*, 27(1).
- Cheung, M. F., Wong, C. S., & Yuan, G. Y. (2017). Why Mutual Trust Leads To Highest Performance: The Mediating Role Of Psychological Contract Fulfillment. *Asia Pacific Journal of Human Resources*, 55(4), 430-453.
- Chiaburu, D. S., Farh, C. I. C., & Van Dyne, L. (2013). Supervisory Epistemic, Ideological, And Existential Responses To Voice: A Motivated Cognition Approach. *Voice and Whistle Blowing in Organizations*, 224-253.
- Chiaburu, D. S., Lorinkova, N. M., & Van Dyne, L. (2013). Employees' social context and change-oriented citizenship: A meta-analysis of leader, coworker, and organizational influences. *Group & Organization Management*, 38(3), 291-333.
- Cialdini, R. B. (2001). Harnessing the Science Of Persuasion. *Harvard Business Review*, 79(9),72-81.
- Coleman, J. S. (1988). Social capital in the creation of human capital. *American Journal of Sociology*, 94, S95-S120.

- Conway, J. M., & Lance, C. E. (2010). What reviewers should expect from authors regarding common method bias in organizational research. *Journal of Business and Psychology, 25*(3), 325-334.
- Costa Jr, P. T., & McCrae, R. R. (1992). Four ways five factors are basic. *Personality and Individual Differences, 13*(6), 653-665.
- Costa, P. T., & McCrae, R. R. (1992). Normal personality assessment in clinical practice: The NEO Personality Inventory. *Psychological Assessment, 4*(1), 5.
- Costa, P. T., & McCrae, R. R. (1992). Revised NEO Personality Inventory (NEO-PI-R) and NEO Five-Factor Inventory (NEO-FFI) professional manual. *Odessa, FL: Psychological Assessment Resources.*
- Crant, J. M., Kim, T. Y., & Wang, J. (2011). Dispositional antecedents of demonstration and usefulness of voice behavior. *Journal of Business and Psychology, 26*(3), 285-297.
- Davidson, T., Van Dyne, L., & Lin, B. (2017). Too Attached To Speak Up? It Depends: How Supervisor-Subordinate Guanxi And Perceived Job Control Influence Upward Constructive Voice. *Organizational Behavior and Human Decision Processes, 143*, 39-53. doi.org/10.1016/j.obhdp.2017.07.002
- Davis, C. G., Thake, J., & Vilhena, N. (2010). Social desirability biases in self-reported alcohol consumption and harms. *Addictive Behaviors, 35*(4), 302-311.
- Deci, E. L., & Ryan, R. M. (2000). The "What" And "Why" Of Goal Pursuits: Human Needs and The Self-Determination Of Behavior. *Psychological Inquiry, 11*(4), 227-268.
- Dessler, G. (2016). Fundamentals of human resource management. *Pearson.*
- Detert, J. R., & Burris, E. R. (2007). Leadership Behavior And Employee Voice: Is The Door Really Open?. *Academy of Management Journal, 50*(4), 869-884.
- Detert, J. R., & Edmondson, A. C. (2005). Everyday failures in organizational learning: Explaining the high threshold for speaking up at work. *Division of Research, Harvard Business School.*

- Detert, J. R., & Edmondson, A. C. (2005, August). No Exit, No Voice: The Bind of Risky Voice Opportunities in Organizations. In *Academy of Management Proceedings* (Vol. 2005, No. 1, pp. 01-06). Briarcliff Manor, NY 10510: *Academy of Management*.
- Detert, J. R., & Edmondson, A. C. (2011). Implicit voice theories: Taken-for-granted rules of self-censorship at work. *Academy of Management Journal*, 54(3), 461-488.
- Detert, J. R., & Treviño, L. K. (2010). Speaking up to higher-ups: How supervisors and skip-level leaders influence employee voice. *Organization Science*, 21(1), 249-270.
- DiRenzo, M. S., Xu, M., & Duan, Y. (2014). When Do Emotionally Exhausted Employees Speak Up? Exploring the Potential Curvilinear Relationship between Emotional Exhaustion and Voice. *Journal of Organizational Behavior*, 35(7), 1018-041.
- Dormann, C., & Griffin, M. A. (2015). Optimal Time Lags In Panel Studies. *Psychological Methods*, 20(4), 489.
- Drescher, G. (2017). Delegation outcomes: perceptions of leaders and follower's satisfaction. *Journal of Managerial Psychology*, 32(1), 2-15. doi.org/10.1108/JMP-05-2015-0174.
- Duan, J., Li, C., Xu, Y., & Wu, C. H. (2017). Transformational leadership and employee voice behavior: A Pygmalion mechanism. *Journal of Organizational Behavior*, 38(5), 650-670.
- Duan, J., Lapointe, E., Xu, Y., & Brooks, S. (2019). Why do employees speak up? Examining the roles of LMX, perceived risk and perceived leader power in predicting voice behavior. *Journal of Managerial Psychology*, 34(8), 560-572.
- Dundon, T., Wilkinson*, A., Marchington, M., & Ackers, P. (2004). The meanings and purpose of employee voice. *The International Journal of Human Resource Management*, 15(6), 1149-1170.
- Dutton, J. E., & Ashford, S. J. 1993. Selling issues to top management. *Academy of Management Review*, 18: 397-428.

- Durcevic, S. (2020). Your Modern Business Guide To Data Analysis Methods And Techniques. Recuperado de: [https://www. datapine. com/blog/data-analysis-methods-and-techniques](https://www.datapine.com/blog/data-analysis-methods-and-techniques).
- Dvir, T., Eden, D., Avolio, B. J., & Shamir, B. (2002). Impact of transformational leadership on follower development and performance: A field experiment. *Academy of Management Journal*, 45(4), 735-744. [://doi.org/10.5465/3069307](https://doi.org/10.5465/3069307).
- Durcevic, S. (2020). Your Modern Business Guide To Data Analysis Methods And Techniques. Recuperado de: [https://www. datapine. com/blog/data-analysis-methods-and-techniques](https://www.datapine.com/blog/data-analysis-methods-and-techniques).
- Edmondson, A. C. (2003). Speaking Up In The Operating Room: How Team Leaders Promote Learning In Interdisciplinary Action Teams. *Journal of Management Studies*, 40(6), 1419-1452. doi.org/10.1111/1467-6486.00386.
- Edmondson, A. C. (2004). Learning from mistakes is easier said than done: Group and organizational influences on the detection and correction of human error. *The Journal of Applied Behavioral Science*, 40(1), 66-90.
- Eisenberger, R., Armeli, S., Rexwinkel, B., Lynch, P. D., & Rhoades, L. (2001). Reciprocation of Perceived Organizational Support. *Journal of Applied Psychology*, 86(1), 42.
- Elsaied, M. M. (2019). Supportive leadership, proactive personality and employee voice behavior. *American Journal of Business*, 34(1), 2-18.
- Erez, A., & Judge, T. A. (2001). Relationship of core self-evaluations to goal setting, motivation, and performance. *Journal of Applied Psychology*, 86(6), 1270.
- Eto, K., & Watanabe, N. (2014). Impact of core self-evaluations on in-role and extra-role performance: Voice and self-evaluation maintenance. *Japanese Journal of Administrative Science*, 27(2), 97-113.
- Eysenck, H. J., & Eysenck, S. B. G. (1968). Eysenck personality inventory manual. *San Diego, California: Educational and Industrial Testing Service*.

- Farh, C.I. and Chen, Z. (2014), "Beyond the individual victim: Multilevel consequences of abusive supervision in teams," *Journal of Applied Psychology*, Vol.99. pp.1074. doi.org/10.1037/a0037636.
- Fast, N. J., Burris, E. R., & Bartel, C. A. (2014). Managing to stay in the dark: Managerial self-efficacy, ego defensiveness, and the aversion to employee voice. *Academy of Management Journal*, 57(4), 1013-1034.
- Ferris, D. L., Berry, J., Brown, D. J., & Lian, H. (2008, August). When silence isn't golden: measuring ostracism in the workplace. In *Academy of Management Proceedings* (Vol. 2008, No. 1, pp. 1-6). Briarcliff Manor, NY 10510: *Academy of Management*.
- Ferris, D. L., Brown, D. J., Berry, J. W., & Lian, H. (2008). The development and validation of the Workplace Ostracism Scale. *Journal of Applied Psychology*, 93(6), 1348.
- Ferris, D. L., Johnson, R. E., Rosen, C. C., Djurdjevic, E., Chang, C. H. D., & Tan, J. A. (2013). When is success not satisfying? Integrating regulatory focus and approach/avoidance motivation theories to explain the relation between core self-evaluation and job satisfaction. *Journal of Applied Psychology*, 98(2), 342.
- Fiedler, F. E. (1964). A contingency model of leadership effectiveness. In *Advances in experimental social psychology* (Vol. 1, pp. 149-190). *Academic Press*.
- Frese, M., & Fay, D. (2001). Personal initiative: An active performance concept for work in the 21st century. *Research in Organizational Behavior*, 23, 133-187.
- Frese, M., Teng, E., & Wijnen, C. J. (1999). Helping to Improve Suggestion Systems: Predictors of Making Suggestions In Companies. *Journal of Organizational Behavior*, 1139-1155.
- Fuller, J. B., Marler, L. E., & Hester, K. (2006). Promoting felt responsibility for constructive change and proactive behavior: Exploring aspects of an elaborated model of work design. *Journal of Organizational Behavior*, 27, 1089-1120

- Fuller, J. B., Marler, L. E., & Hester, K. (2006). Promoting felt responsibility for constructive change and proactive behavior: Exploring aspects of an elaborated model of work design. *Journal of Organizational Behavior: The International Journal of Industrial, Occupational and Organizational Psychology and Behavior*, 27(8), 1089-1120.
- Furnham, A., & Zacherl, M. (1986). Personality and job satisfaction. *Personality and Individual Differences*, 7(4), 453-459.
- Gao, L., Janssen, O., & Shi, K. (2011). Leader trust and employee voice: The moderating role of empowering leader behaviors. *The Leadership Quarterly*, 22(4), 787-798. Aug 1;22(4):787-98.
- Gardner, D.G., Van Dyne, L. and Pierce, J.L. (2004), "The effects of pay level on organization-based self-esteem and performance: A field study," *Journal of Occupational and Organizational Psychology*, Vol 77, pp.307-322. [org/10.1348/0963179041752646](https://doi.org/10.1348/0963179041752646).
- Garvin, D. A. (2013). How Google Sold Its Engineers On Management. *Harvard Business Review*. 91, 74–82.
- George, J. M. (2007). 9 Creativity in organizations. *Academy of Management Annals*, 1(1), 439-477.
- Gollan, P. J., & Wilkinson, A. (2007). Contemporary developments in information and consultation. *The International Journal of Human Resource Management*, 18(7), 1133-1144.
- Grant, A. M. (2013). Rocking the boat but keeping it steady: The role of emotion regulation in employee voice. *Academy of Management Journal*, 56(6), 1703-1723.
- Grant, A. M., Parker, S., & Collins, C. (2009). Getting credit for proactive behavior: Supervisor reactions depend on what you value and how you feel. *Personnel Psychology*, 62(1), 31-55.
- Griffeth, R. W., Hom, P. W., & Gaertner, S. (2000). A Meta-Analysis Of Antecedents And Correlates Of Employee Turnover: Update, Moderator Tests,

- And Research Implications For The Next Millennium. *Journal of Management*, 26(3), 463-488.
- Gross, J.J. & John, O.P. (2003). Individual differences in two emotion regulation processes: Implications for affect, relationships, and well-being. *Journal of Personality and Social Psychology*, 85, 348-362.
- Gross, J.J. (2001). Emotion regulation in adulthood: Timing is everything. *Current Directions in Psychological Science*, 10, 214-219.
- Gross, J.J. (2002). Emotion regulation: Affective, cognitive and social consequences. *Psychophysiology*, 39, 281-291.
- Gross, J.J., & Thompson, R.A. (2007). Emotion regulation: Conceptual foundations. In J.J. Gross (Ed.), *Handbook of emotion regulation* (pp. 3-24). *New York: Guilford Press*.
- Guo, Y., Zhu, Y., & Zhang, L. (2020). Inclusive leadership, leader identification and employee voice behavior: The moderating role of power distance. *Current Psychology*, 1-10.
- Hair A. Tatham, and Black. *Análisis multivariante*. 1998.
- Hair, J. F., Anderson, R. E., Tatham, R. L., & Black, W. C. (1999). *Análisis multivariante* (Vol. 491). *Madrid: Prentice Hall*.
- Halperin, E. (2008). Group-based hatred in intractable conflict in Israel. *Journal of Conflict Resolution*, 52(5), 713-736.
- Halperin, E., Canetti, D., & Kimhi, S. (2012). In Love With Hatred: Rethinking the Role Hatred Plays in Shaping Political Behavior 1. *Journal of Applied Social Psychology*, 42(9), 2231-2256.
- Halperin, E., Russell, A. G., Dweck, C. S., & Gross, J. J. (2011). Anger, hatred, and the quest for peace: Anger can be constructive in the absence of hatred. *Journal of Conflict Resolution*, 55(2), 274-291.
- Harter, S. (1990). Self and identity development.
- Hirschman, A.O.(1970), "Exit, voice, and loyalty: Responses to decline in firms, organizations, and states" (Vol. 25). *Harvard University Press*.

- Hitlan, R. T., & Noel, J. (2009). The Influence Of Workplace Exclusion And Personality On Counterproductive Work Behaviours: An Interactionist Perspective. *European Journal of Work and Organizational Psychology*, 18(4), 477-502.
- Hitlan, R. T., Clifton, R. J., & DeSoto, M. C. (2006). Perceived exclusion in the workplace: The moderating effects of gender on work-related attitudes and psychological health. *North American Journal of Psychology*, 8(2), 217-236.
- Ho, J. C. (2017). The effect of supervisor support on employee voice behavior based on the self-determination theory: the moderating effect of impression management motive. *Journal of Entrepreneurship and Organization Management*, 6(21), 1-8.
- Hochwarter, W. A., & Treadway, D. C. (2003). The Interactive Effects Of Negative and Positive Affect On The Politics Perceptions–Job Satisfaction Relationship. *Journal of Management*, 29(4), 551-567.
- Hofstede, G. (1980). Culture and organizations. *International Studies of Management & Organization*, 10(4), 15-41.
- Hofstede, G. (1980). Motivation, Leadership, And Organization: Do American Theories Apply Abroad?. *Organizational Dynamics*, 9(1), 42-63.
- Hsiung, H. H., & Tsai, W. C. (2017). The Joint Moderating Effects Of Activated Negative Moods and Group Voice Climate on the Relationship between Power Distance Orientation and Employee Voice Behavior. *Applied Psychology*, 66(3), 487-514. doi.org/10.1111/apps.12096.
- Hu, L. T., & Bentler, P. M. (1998). Fit indices in covariance structure modeling: Sensitivity to under parameterized model misspecification. *Psychological Methods*, 3(4), 424-453.
- Hulin, C. L., Henry, R. A., & Noon, S. L. (1990). Adding a dimension: Time as a factor in the generalizability of predictive relationships. *Psychological Bulletin*, 107(3), 328.

- Hung, H. K., Yeh, R. S., & Shih, H. Y. (2012). Voice Behavior And Performance Ratings: The Role of Political Skill. *International Journal of Hospitality Management*, 31(2), 442-450.
- Igen, D. R., Fisher, C. D., & Taylor, M. S. (1979). Consequences of Individual Feedback on Behavior In Organizations. *Journal of Applied Psychology*, 64(4), 349.
- Ito, J. and Peterson, R. (1986), "Effects of Task Difficulty And Interunit Interdependence On Information Processing Systems", *Academy of Management Journal*, 1/29, pp. 139-149.
- Jensen, K. B. (Ed.). (2020). A handbook of media and communication research: Qualitative and quantitative methodologies, *Routledge*.
- Janssen, O. (2005). The joint impact of perceived influence and supervisor supportiveness on employee innovative behaviour. *Journal of Occupational and Organizational Psychology*, 78(4), 573-579. doi.org/10.1348/096317905X25823.
- Janssen, O. and Gao, L. (2015), "Supervisory responsiveness and employee self-perceived status and voice behavior," *Journal of Management*, Vol.41, pp.1854-1872. doi.org/10.1177/0149206312471386.
- Jiang, Z., Le, H., & Gollan, P. J. (2017). Cultural Intelligence and Voice Behavior Among Migrant Workers: The Mediating Role Of Leader–Member Exchange. *The International Journal of Human Resource Management*, 1-31.
- Joiner, T. A., Bakalis, S., & Choy, J. (2006, January). Delegation, job satisfaction and subordinate performance: The mediating effect of leader-member exchange. *In 20th Australia and New Zealand Academy of Management Conference*.
- Joo, B. K., Jeung, C. W., & Yoon, H. J. (2010). Investigating the influences of core self-evaluations, job autonomy, and intrinsic motivation on in-role job performance. *Human Resource Development Quarterly*, 21(4), 353-371.
- Judge, T. A., & Bono, J. E. (2001). Relationship of core self-evaluations traits—self-esteem, generalized self-efficacy, locus of control, and emotional stability—with

- job satisfaction and job performance: A meta-analysis. *Journal of applied Psychology*, 86(1), 80.
- Judge, T. A., & Hurst, C. (2007). Capitalizing on one's advantages: Role of core self-evaluations. *Journal of Applied Psychology*, 92(5), 1212.
- Judge, T. A., & Kammeyer-Mueller, J. D. (2011). Implications of core self-evaluations for a changing organizational context. *Human Resource Management Review*, 21(4), 331-341.
- Judge, T. A., Bono, J. E., Erez, A., & Locke, E. A. (2005). Core self-evaluations and job and life satisfaction: the role of self-concordance and goal attainment. *Journal of Applied Psychology*, 90(2), 257.
- Judge, T. A., Erez, A., Bono, J. E., & Thoresen, C. J. (2003). The core self-evaluations scale: Development of a measure. *Personnel Psychology*, 56(2), 303-331.
- Judge, T. A., Locke, E. A., Durham, C. C., & Kluger, A. N. (1998). Dispositional effects on job and life satisfaction: The role of core evaluations. *Journal of Applied Psychology*, 83(1), 17.
- Jung Y.(2014) Employee Voice and Recipients' Appraisals/Reactions: The Effects of Speech Style, Voice Type, and Voicer Status. Electronic Thesis and Dissertation Repository, *The University of Western Ontario, Ontario*.
- Kacmar, K. M., Collins, B. J., Harris, K. J., & Judge, T. A. (2009). Core self-evaluations and job performance: the role of the perceived work environment. *Journal of Applied Psychology*, 94(6), 1572.
- Kakkar, H., Tangirala, S., Srivastava, N. K., & Kamdar, D. (2016). The dispositional antecedents of promotive and prohibitive voice. *Journal of Applied Psychology*, 101(9), 1342.
- Kammeyer-Mueller, J. D., Judge, T. A., & Scott, B. A. (2009). The role of core self-evaluations in the coping process. *Journal of Applied Psychology*, 94(1), 177.

- Karatepe, O. M., Haktanir, M., & Yorganci, I. (2010). The impacts of core self-evaluations on customer-related social stressors and emotional exhaustion. *The Service Industries Journal*, 30(9), 1565-1579.
- Kastelle, T.(2013), "Hierarchy is overrated," *Harvard Business Review*, 20.
- Kazemitabar, M., Lajoie, S. P., & Doleck, T. (2021). Analysis of emotion regulation using posture, voice, and attention: A qualitative case study. *Computers and Education Open*, 2, 100030.
- Kim, M., Shin, Y., & Gang, M. C. (2017). Can Misfit Be a Motivator of Helping and Voice Behaviors? Role of Leader–Follower Complementary Fit in Helping and Voice Behaviors. *Psychological Reports*, 120(5), 870-894.
- Kish-Gephart, J. J., Detert, J. R., Treviño, L. K., & Edmondson, A. C. (2009). Silenced by Fear The Nature, Sources, and Consequences Of Fear At Work. *Research in Organizational Behavior*, 29, 163-193.
- Klass B.S., Olson, Buchanan, J.B., & Ward, A.K. (2012). The Determinants of Alternate forms of Workplace Voice: An Integrative Perspective. *Journal of Management*. 38, 314-45.
- Kocakaya, S., & Kocakaya, F. (2014). A Structural Equation Modeling On Factors Of How Experienced Teachers Affect The Students' Science and Mathematics Achievements. *Education Research International*, 2014, 1-8
- Kong, F., Huang, Y., Liu, P., & Zhao, X. (2017). Why voice behavior? An integrative model of the need for affiliation, the quality of leader–member exchange, and group cohesion in predicting voice behavior. *Group & Organization Management*, 42(6), 792-818.
- Korsgaard, M. A., Roberson, L., & Rymph, R. D. (1998). What Motivates Fairness? The Role Of Subordinate Assertive Behavior On Manager's Interactional Fairness. *Journal of Applied Psychology*, 83(5), 731.
- Krejcie, R. V., & Morgan, D. W. (1970). Determining Sample Size For Research Activities. *Educational and Psychological Measurement*, 30(3), 607-610.
- Krejcie, R. V., & Morgan, D. W. (1970). Determining sample size for research activities. *Educational and Psychological Measurement*, 30(3), 607-610.

- Kuenzi, M., & Schminke, M. (2009). Assembling Fragments Into A Lens: A Review, Critique, and Proposed Research Agenda For The Organizational Work Climate Literature. *Journal of Management*, 35(3), 634-717.
- Lam, C. F., & Mayer, D. M. (2014). When do employees speak up for their customers? A model of voice in a customer service context. *Personnel Psychology*, 67(3), 637-666.
- Leanna, C. (1986), Predictors and consequences and delegation, *Academy of Management Journal*, 4/29, pp754-774.
- Leary, Koch, & Hechenbleikner, (2001). Leary, M. R., Koch, E., & Hechenbleikner, N. (2001). En MR Leary. *Interpers. Reject*, 14, 145-166.
- Lebel, R. D. (2017). Moving Beyond Fight And Flight: A Contingent Model Of How The Emotional Regulation Of Anger And Fear Sparks Proactivity. *Academy of Management Review*, 42(2), 190-206. doi.org/10.5465/amr.2014.0368.
- Lee, C. H., Wang, M. L., & Liu, M. S. (2017). When and How Does Psychological Voice Climate Influence Individual Change Readiness? The Mediating Role of Normative Commitment and the Moderating Role of Work Engagement. *Frontiers in Psychology*, 8, 1737 doi.org/10.3389/fpsyg.2017.01737.
- Lee, G. L., Diefendorff, J. M., Kim, T. Y., & Bian, L. (2014). Personality and participative climate: Antecedents of distinct voice behaviors. *Human Performance*, 27(1), 25-43.
- Lepine, J.A. and Van Dyne, L. (1998), "Predicting voice behavior in work groups," *Journal of Applied Psychology*, Vol.83, pp.853. doi.org/10.1037/0021-9010.83.6.853;
- LePine, J.A. and Van Dyne, L. (2001), "Voice and cooperative behavior as contrasting forms of contextual performance: evidence of differential relationships with big five personality characteristics and cognitive ability," *Journal of Applied Psychology*, Vol. 86, p.326. .doi.org/10.1037/0021-9010.86.2.326.

- Li, W. D., Frese, M., & Haidar, S. (2017). Distinguishing Proactivity and Citizenship Behavior. *In The Oxford Handbook of Organizational Citizenship Behavior*.
- Liang, J., & Gong, Y. (2013). Capitalizing on proactivity for informal mentoring received during early career: The moderating role of core self-evaluations. *Journal of Organizational Behavior*, 34(8), 1182-1201. doi.org/10.1037/0021-9010.83.6.853.
- Liang, J., Farh, C. I., & Farh, J. L. (2012). Psychological Antecedents of Promotive And Prohibitive Voice: A Two-Wave Examination. *Academy of Management Journal*, 55(1), 71-92. doi.org/10.5465/amj.2010.0176.
- Lin, S. H. J., & Johnson, R. E. (2015). A Suggestion To Improve A Day Keeps Your Depletion Away: Examining Promotive And Prohibitive Voice Behaviors Within A Regulatory Focus And Ego Depletion Framework. *Journal of Applied Psychology*, 100(5), 1381.
- LIU, Y. R., YIN, K., & LI, Y. X. (2013). A research on the interactive impact among employee's political skill, voice behavior and perceived organizational status. *Modern Finance and Economics-Journal of Tianjin University of Finance and Economics*, 33(2), 65-71.
- Locke, E. A., McClear, K., & Knight, D. (1996). Self-esteem and work. *International Review of Industrial/Organizational Psychology*, 11, 1-32.
- Lutgans F, Hodegtts R. 2004. Business, 2nd ed. *McGraw Hill: New York*.
- MacKenzie, S. B., Podsakoff, P. M., & Podsakoff, N. P. (2011). Challenge-oriented organizational citizenship behaviors and organizational effectiveness: Do challenge-oriented behaviors really have an impact on the organization's bottom line?. *Personnel Psychology*, 64(3), 559-592.
- Madrid, H. P. (2020). Emotion regulation, positive affect, and promotive voice behavior at work. *Frontiers in Psychology*, 11, 1739.
- Mallory, D. B., Rupp, D. E., Pandey, N., & Tay, L. (2020). The Effect of Employee Proactive Personality and Felt Responsibility on Individual Corporate Social

- Responsibility Behaviors: The CSR Context Matters. *Journal of Sustainability Research*, 3(1).
- Maoz, I., & McCauley, C. (2008). Threat, Dehumanization, And Support For Retaliatory Aggressive Policies In Asymmetric Conflict. *Journal of Conflict Resolution*, 52(1), 93-116.
- Markus, H. R. & Kitayama, S. 1991. Culture and the self: Implications for cognition, emotion and motivation. *Psychological Review*, 98: 224-253.
- Markus, H. R., Mullally, P. R., & Kitayama, S. (1997, January). Selfways: Diversity in modes of cultural participation. In Emory symposia in cognition (Vol. 7, pp. 13-61). *Cambridge University Press*.
- Martin, S.L., Liao, H. and Campbell, E.M. (2013), "Directive versus empowering leadership: a field experiment comparing impacts on task proficiency and proactivity", *Academy of Management Journal*, Vol. 56 No. 5, pp. 1372-1395.
- Maslow, A., & Lewis, K. J. (1987). Maslow's hierarchy of needs. *Salenger Incorporated*, 14, 987.
- Mauss, I. B., Bunge, S. A., & Gross, J. J. (2007). Automatic emotion regulation. *Social and Personality Psychology Compass*, 1(1), 146-167.
- Mayer, J. D., & Salovey, P. (1993). The intelligence of emotional intelligence.
- Mayer, J. D., Salovey, P., & Caruso, D. R. (2004). TARGET ARTICLES:" Emotional Intelligence: Theory, Findings, And Implications". *Psychological Inquiry*, 15(3), 197-215.
- Maynes, T.D. and Podsakoff, P.M. (2014), "Speaking more broadly: An examination of the nature, antecedents, and consequences of an expanded set of employee voice behaviors," *Journal of Applied Psychology*, Vol.99, pp.87. [.doi.org/10.1037/a0034284](https://doi.org/10.1037/a0034284).
- McAllister, D. W., Mitchell, T. R., & Beach, L. R. (1979). The contingency model for the selection of decision strategies: An empirical test of the effects of significance, accountability, and reversibility. *Organizational Behavior and Human Performance*, 24(2), 228-244. [doi.org/10.1016/0030-5073\(79\)90027-8](https://doi.org/10.1016/0030-5073(79)90027-8).

- McCrae, R. R., & Costa, P. T. (1991). The NEO Personality Inventory: Using the Five-Factor Model in Counseling. *Journal of Counseling & Development*, 69(4), 367-372.
- Mesmer-Magnus, J. R., & Viswesvaran, C. (2005). Whistleblowing in organizations: An examination of correlates of whistleblowing intentions, actions, and retaliation. *Journal of Business Ethics*, 62(3), 277-297.
- Mesquita, B., & Markus, H. R. (2004). Culture and emotion: Models of agency as sources of cultural variation in emotion. In A. S. R. Manstead, N. Frijda, & A. Fischer (Eds.), *Feelings and emotions: The Amsterdam Symposium* (pp. 341-358). *New York: Cambridge University Press*.
- Miceli, M. P., Near, J. P., & Dworkin, T. M. (2008). Whistle-blowing in organizations. *Psychology Press*.
- Milliken, F. J., Morrison, E. W., & Hewlin, P. F. (2003). An Exploratory Study Of Employee Silence: Issues That Employees Don't Communicate Upward And Why. *Journal of Management Studies*, 40, 1453-1476. doi:10.1111/1467-6486.00387
- Minzberg, H. (1979). The structuring of organizations. *Englewood Cliffs, NJ: Prentice Hall*.
- Mitchell, T. R., & James, L. R. (2001). Building Better Theory: Time and The Specification of When Things Happen. *Academy of Management Review*, 26(4), 530-547.
- Mor Barak, M. E., & Cherin, D. A. (1998). A Tool to Expand Organizational Understanding of Workforce Diversity. *Administration in Social Work*, 22(1), 47-64. doi:10.1300/J147v22n01_04.
- Mor Barak, M.E. (2011), *Managing Diversity: Toward A Globally Inclusive Workplace*, Sage Publications, Thousand Oaks, CA.
- Morrison & Phelps 1999; Morrison, E. W., & Phelps, C. C. (1999). Taking Charge At Work: Extrarole Efforts To Initiate Workplace Change. *Academy of management Journal*, 42(4), 403-419.

- Morrison EW. 2011. Voice And Silence Within Organizations: Literature Review And Directions For Future Research. *Academy of Management Annals*, 5:373–412.
- Morrison, E. W. (1994). Role definitions and organizational citizenship behavior: The importance of the employee's perspective. *Academy of Management Journal*, 37(6), 1543-1567.
- Morrison, E. W. (2014). Employee Voice And Silence. Annual. Review. Organ. Psychol. Organ. Behav, 1(1), 173-197.
- Morrison, E. W., & Milliken, F. J. (2000). Organizational silence: A barrier to change and development in a pluralistic world. *Academy of Management Review*, 25(4), 706-725.
- Morrison, E. W., & Milliken, F. J. (2000). Organizational Silence: A Barrier To Change And Development in a Pluralistic World. *Academy of Management Review*, 25(4), 706-725. doi.org/10.5465/amr.2000.3707697.
- Morrison, E. W., & Phelps, C. C. 1999. Taking charge at work: Extrarole efforts to initiate workplace change. *Academy of Management Journal*, 42: 403-419
- Morrison, E. W., & Rothman, N. B. (2009). Silence and the Dynamics Of Power. *Voice and Silence in Organizations*, 6, 111-134.
- Morrison, E. W., Wheeler-Smith, S. L., & Kamdar, D. (2011). Speaking Up In Groups: A cross-Level Study Of Group Voice Climate And Voice. *Journal of Applied Psychology*, 96, 183–191. <http://dx.doi.org/10.1037/a0020744>.
- Nakagawa, T., Gondo, Y., Ishioka, Y., & Masui, Y. (2017). Age, emotion regulation, and affect in adulthood: The mediating role of cognitive reappraisal. *Japanese Psychological Research*, 59(4), 301-308.
- Nemeth, C. J. (1997). Managing innovation: When less is more. *California Management Review*, 40(1), 59-74.
- Newman, A., Donohue, R., & Eva, N. (2017). Psychological Safety: A systematic Review of The Literature. *Human Resource Management Review*, 27(3), 521-535.

- Ng, T. W., & Feldman, D. C. (2012). Employee voice behavior: A meta-analytic test of the conservation of resources framework. *Journal of Organizational Behavior, 33*(2), 216-234.
- Ng, T. W., & Feldman, D. C. (2013). Age and innovation-related behavior: The joint moderating effects of supervisor undermining and proactive personality. *Journal of Organizational Behavior, 34*(5), 583-606.
- Nunnally, J. C., & Bernstein, I. H. (1994). Psychological theory, 131-147.
- Ou, A. Y., Tsui, A. S., Kinicki, A. J., Waldman, D. A., Xiao, Z., & Song, L. J. (2014). Humble Chief Executive Officers' Connections To Top management Team Integration And Middle Managers' Responses. *Administrative Science Quarterly, 59*, 34-72. <http://dx.doi.org/10.1177/0001839213520131>.
- Oyserman, D., Coon, H. M., & Kimmelmeier, M. (2002). Rethinking individualism and collectivism: Evaluation of theoretical assumptions and meta-analyses. *Psychological Bulletin, 128*,3-72.
- Parker S. K., Bindl U.,& Strauss K. (2010). Making Things Happen: A Model of Proactive Motivation. *Journal of Management, 36*: 827-856 [doi.org/10.1177/0149206310363732](http://dx.doi.org/10.1177/0149206310363732).
- Parker, S. K., Williams, H. M., & Turner, N. (2006). Modeling the antecedents of proactive behavior at work. *Journal of Applied Psychology, 91*(3), 636.
- Parker, S. K., & Collins, C. G. (2010). Taking stock: Integrating and differentiating multiple proactive behaviors. *Journal of Management, 36*(3), 633-662.
- Pekrun, R. (2006). The Control-value theory of achievement emotions: Assumptions, corollaries, and implications for educational research and practice. *Educational Psychology Review, 18*, 315-341.
- Pekrun, R., Elliot, A.J., & Maier, M.A. (2006). Achievement goals and discrete achievement emotions: A theoretical model and prospective test. *Journal of Educational Psychology, 98*, 583-597.
- Pelled, L., Ledford, Jr, G. E., & Mohrman, S. (1999). Demographic Dissimilarity and Workplace Inclusion. *Journal of Management Studies, 36*(7), 1013-1031. [doi:10.1111/1467-6486.00168](http://dx.doi.org/10.1111/1467-6486.00168).

- Pierce, J. L., & Gardner, D. G. (2004). Self-esteem within the work and organizational context: A review of the organization-based self-esteem literature. *Journal of Management*, 30(5), 591-622.
- Pinder CC, Harlos KP. (2001). Employee Silence: Quiescence And Acquiescence As Responses To Perceived Injustice. *Res. Pers. Hum. Res. Manag.* 20:331-69.
- Plaut, V. C., Garnett, F. G., Buffardi, L. E., & Sanchez-Burks, J. (2011). "What about me?" Perceptions of exclusion and Whites' reactions to multiculturalism. *Journal of Personality and Social Psychology*, 101(2), 337.
- Podsakoff, N. P., Whiting, S. W., Podsakoff, P. M., & Blume, B. D. (2009). Individual-and organizational-level consequences of organizational citizenship behaviors: A meta-analysis. *Journal of Applied Psychology*, 94(1), 122.
- Podsakoff, P. M., MacKenzie, S. B., Lee, J. Y., & Podsakoff, N. P. (2003). Common method biases in behavioral research: a critical review of the literature and recommended remedies. *Journal of Applied Psychology*, 88(5), 879.
- Podsakoff, P. M., MacKenzie, S. B., Paine, J. B., & Bachrach, D. G. (2000). Organizational citizenship behaviors: A critical review of the theoretical and empirical literature and suggestions for future research. *Journal of Management*, 26(3), 513-563.
- Premeaux, S. F., & Bedeian, A. G. (2003). Breaking the silence: The moderating effects of self-monitoring in predicting speaking up in the workplace. *Journal of Management Studies*, 40(6), 1537-1562.
- Prince, R. and Rao, M.K. (2021), "Efficacy beliefs and employee voice: the role of perceived influence and manager openness", *International Journal of Productivity and Performance Management*, Vol. ahead-of-print No. ahead-of-print. <https://doi.org/10.1108/IJPPM-05-2020-0266>.
- Pyclik, A. (2019). Antecedents of Voice: The Moderating Role of Proactive Personality.

- Rich, B. L., Lepine, J. A., & Crawford, E. R. (2010). Job engagement: Antecedents and effects on job performance. *Academy of Management Journal*, 53(3), 617-635.
- Sagnak, M. (2012). The empowering leadership and teachers innovative behavior: The mediating role of innovation climate. *African Journal of Business Management*, 6(4), 1635-1641. DOI: 10.5897/AJBM11.2162.
- Satterstrom, P., Kerrissey, M., & DiBenigno, J. (2021). The voice cultivation process: How team members can help upward voice live on to implementation. *Administrative Science Quarterly*, 66(2), 380-425.
- Schneider, B. (1990). *Organizational Climate And Culture*. Pfeiffer.
- Schneider, K. T., Hitlan, R. T., & Radhakrishnan, P. (2000). An examination of the nature and correlates of ethnic harassment experiences in multiple contexts. *Journal of Applied Psychology*, 85(1), 3.
- Schriesheim, C.A., Neider, L.L. and Scandura, T.A. (1998), "Delegation and leader-member exchange: Main effects, moderators, and measurement issues," *Academy of Management Journal*, Vol.41, pp.298-318. doi.org/10.5465/256909.
- Schutz, P.A., Quijada, P.D., de Vries, S., & Lynde, M. (2011). Emotion in educational context. In S. Järvelä (Ed.), *Social and emotional aspects of learning* (pp. 64-69). Oxford: Elsevier.
- Schwartz, J., & Wald, M. L. (2003). Smart People Working Collectively Can Be Dumber Than The Sum Of Their Brains: Groupthink Is 30 Years Old, and Still Going Strong. *New York Times*, 9.
- Schwartz, S. H., & Bardi, A. (2001). Value hierarchies across cultures: Taking a similarities perspective. *Journal of Cross-Cultural Psychology*, 32(3), 268-290.
- Scott, S. G., & Bruce, R. A. 1994. Determinants of innovative behavior: A path model of individual innovation in the workplace. *Academy of Management Journal*, 37: 580-607
- Scott, B. A., & Judge, T. A. (2009). The popularity contest at work: Who wins, why, and what do they receive?. *Journal of Applied Psychology*, 94(1), 20.

- Scott, K. L., Restubog, S. L. D., & Zagenczyk, T. J. (2013). A social exchange-based model of the antecedents of workplace exclusion. *Journal of Applied Psychology, 98*(1), 37.
- Scott, K. L., Zagenczyk, T. J., Schippers, M., Purvis, R. L., & Cruz, K. S. (2014). Co-worker exclusion and employee outcomes: An investigation of the moderating roles of perceived organizational and social support. *Journal of Management Studies, 51*(8), 1235-1256.
- Seibert, S. E., Kraimer, M. L., & Crant, J. M. (2001). What do proactive people do? A longitudinal model linking proactive personality and career success. *Personnel Psychology, 54*(4), 845-874.
- Sekaran, U. (2003). *Research Methods For Business*, Fourth Edition.
- Sheng, Z. (2020). Knowledge and Skill Predictors of Voice Behavior: Voice as an Upward Influence.
- Shore, L. M., Randel, A. E., Chung, B. G., Dean, M. A., Ehrhart, K. H., & Singh, G. (2011). Inclusion and Diversity in Work Groups: A Review and Model for Future Research. *Journal of Management, 37*(4), 1262–1289. doi:10.1177/0149206310385943.
- Son, S. (2019). The role of supervisors on employees' voice behavior. *Leadership & Organization Development Journal, 40*(1),85-96.
- Song, Y., Peng, P., & Yu, G. (2020). I would speak up to live up to your trust: the role of psychological safety and regulatory focus. *Frontiers in Psychology, 10*, 2966
- Song, X., Wu, W., Hao, S., Lu, X., Zhang, Y. and Liu, Y. (2017), "On-work or off-work relationship? An engagement model of how and when leader-member exchange and leader-member guanxi promote voice behavior", *Chinese Management Studies*, Vol.11 No 3, pp. 441-462. doi/10.1108/CMS-03-2017-0058.
- Soric, I., Penezić, Z., & Burić, I. (2013). Big Five personality traits, cognitive appraisals and emotion regulation strategies as predictors of achievement emotions. *Psihologijske Teme, 22*(2), 325-349.

- Spreitzer, G. M. (1995). Psychological Empowerment In The Workplace: Dimensions, Measurement, and Validation. *Academy of Management Journal*, 38(5), 1442-1465.
- Srivastava, A., Locke, E. A., Judge, T. A., & Adams, J. W. (2010). Core self-evaluations as causes of satisfaction: The mediating role of seeking task complexity. *Journal of Vocational Behavior*, 77(2), 255-265.
- Stamper, C. L., & Dyne, L. V. (2001). Work status and organizational citizenship behavior: A field study of restaurant employees. *Journal of Organizational Behavior: The International Journal of Industrial, Occupational and Organizational Psychology and Behavior*, 22(5), 517-536.
- Sullman, M. J., & Taylor, J. E. (2010). Social desirability and self-reported driving behaviours: Should we be worried?. *Transportation Research Part F: Traffic Psychology and Behaviour*, 13(3), 215-221.
- Svendsen, M., Jønsson, T. S., & Unterrainer, C. (2016). Participative supervisory behavior and the importance of feeling safe and competent to voice. *Journal of Personnel Psychology*, 15(1), 1-18.
- Tajfel, H., & Turner, J. C. (1986). The Social Identity Theory Of Inter Group Behavior In S Worchel & WG Austin (Eds) *Psychology of intergroup relations*. Chicago: Nelson.
- Tajfel, H., Turner, J. C., Austin, W. G., & Worchel, S. (1979). An integrative theory of intergroup conflict. *Organizational Identity: A Reader*, 56, 65.
- Takeuchi, R., Chen, Z., & Cheung, S. Y. (2012). Applying uncertainty management theory to employee voice behavior: An integrative investigation. *Personnel Psychology*, 65(2), 283-323.
- Tangirala & Ramunjam, 2008). Tangirala, S. and Ramanujam, R. (2008), "Employee silence on critical work issues: The cross-level effects of procedural justice climate," *Personnel Psychology*, Vol.61,pp.37-68.<https://doi.org/10.1111/j.1744-6570.2008.00105>.

- Tangirala S, Kamdar D, Venkataramani V, Parke M. (2013). Doing Right versus Getting Ahead: The Effects Of Duty And Achievement Orientations On Employees' Voice. *Journal of Applied Psychology*, 98(6):1040–50.
- Tangirala, S., & Ramanujam, R. (2008). Exploring Nonlinearity In Employee Voice: The Effects Of Personal Control And Organizational Identification. *Academy of Management Journal*, 51, 1189–1203. <http://dx.doi.org/10.5465/AMJ.2008.35732719>.
- Terre Blanche, M., & Durrheim, K. (1999). Social constructionist methods. Research in Practice: *Applied Methods for the Social Sciences*, 147-172.
- Thomas, K. W., & Velthouse, B. A. (1990). Cognitive Elements Of Empowerment: An “Interpretive” Model Of Intrinsic Task Motivation. *Academy of Management Review*, 15(4), 666-681.
- Timming, A. R., & Johnstone, S. (2015). Employee silence and the authoritarian personality. *International Journal of Organizational Analysis*, 23(1),154-171.
- Tims, M., & Akkermans, J. (2017). Core self-evaluations and work engagement: Testing a perception, action, and development path. *PloS One*, 12(8), e0182745.
- Triandis, H. C. (1995). A theoretical framework for the study of diversity. In M. M. Chemers, S. Oskamp, & M. A. Costanzo (Eds.), *Diversity in organizations: New perspectives for a changing workplace* (pp. 11–36). *Sage Publications, Inc.* <https://doi.org/10.4135/9781452243405.n2>.
- Trommsdorff, G., & Rothbaum, F. (2008). Development of emotion regulation in cultural context. *Blackwell Publishing*.
- Tucker, S., Chmiel, N., Turner, N., Hershcovis, M. S., & Stride, C. B. (2008). Perceived organizational support for safety and employee safety voice: The mediating role of coworker support for safety. *Journal of Occupational Health Psychology*, 13(4), 319.
- Twenge, J. M., Baumeister, R. F., Tice, D. M., & Stucke, T. S. (2001). If you can't join them, beat them: effects of social exclusion on aggressive behavior. *Journal of Personality and Social Psychology*, 81(6), 1058.

- Uhl-Bien, M., Graen, G. B., & Scandura, T. A. (2000). Implications of leader-member exchange (LMX) for strategic human resource management systems: Relationships as social capital for competitive advantage. *Research in Personnel and Human Resources Management*, 18, 137-186.
- Uma, S., & Roger, B. (2003). *Research Methods for Business: A Skill Building Approach. Book.*
- Um-e-Rubbab, & Naqvi SMMR (2020) Employee voice behavior as a critical factor for organizational sustainability in the telecommunications industry. PLoS ONE 15(9): e0238451. <https://doi.org/10.1371/journal.pone.0238451>
- Van Dyne, L. and LePine, J.A. (1998), "Helping and voice extra-role behaviors: Evidence of construct and predictive validity," *Academy of Management Journal*, Vol. 41, pp.108-119. <https://doi.org/10.5465/256902>.
- Van Dyne, L., Ang, S., & Botero, I. C. (2003). Conceptualizing Employee Silence and Employee Voice As Multidimensional Constructs. *Journal of Management Studies*, 40, 1359 –1392. <http://dx.doi.org/10.1111/1467-6486.00384>.
- Van Dyne, L., Kamdar, D., & Joireman, J. (2008). In-Role Perceptions Buffer The Negative Impact of Low LMX on Helping And Enhance The Positive Impact Of High LMX on Voice. *Journal of Applied Psychology*, 93,1195–1207.<http://dx.doi.org/10.1037/0021-9010.93.6.1195>.
- Vandewalle, D., Van Dyne, L., & Kostova, T. (1995). Psychological ownership: An empirical examination of its consequences. *Group & Organization Management*, 20(2), 210-226.
- Ward, A. K. (2013). *Voicing Across Cultures: The Role Of Communication Style And Relationships In Employee Voice And Subsequent Influence* (Doctoral dissertation, *University of South Carolina*).
- Ward, A. K., Ravlin, E. C., Klaas, B. S., Ployhart, R. E., & Buchan, N. R. (2016). When do high-context communicators speak up? Exploring contextual communication orientation and employee voice. *Journal of Applied Psychology*, 101(10), 1498.

- Warren, D. E. (2003). Constructive and destructive deviance in organizations. *Academy of Management Review*, 28(4), 622-632.
- Wei, X., Zhang, Z. X., & Chen, X. P. (2015). I Will Speak Up If My Voice Is Socially Desirable: A Moderated Mediating Process Of Promotive Versus Prohibitive voice. *Journal of Applied Psychology*, 100(5), 1641. doi.org/10.1037/a0039046.
- Weick, K., & Sutcliffe, K. (2001). Managing the unexpected: Assuring high performance in an age of uncertainty. *San Francisco: Wiley*, 1(3), 5.
- Weiss, H. M., & Cropanzano, R. (1996). Affective events theory. *Research in organizational behavior*, 18(1), 1-74.
- Weiss, M., & Morrison, E. W. (2019). Speaking up and moving up: How voice can enhance employees' social status. *Journal of Organizational Behavior*, 40(1), 5-19.
- Whiting, S. W., Maynes, T. D., Podsakoff, N. P., & Podsakoff, P. M. (2012). Effects of message, source, and context on evaluations of employee voice behavior. *Journal of Applied Psychology*, 97(1), 159.
- Whiting, S. W., Podsakoff, P. M., & Pierce, J. R. (2008). Effects of task performance, helping, voice, and organizational loyalty on performance appraisal ratings. *Journal of Applied Psychology*, 93(1), 125.
- Wilkinson, A., Dundon, T., Marchington, M., & Ackers, P. (2004). Changing patterns of employee voice: Case studies from the UK and Republic of Ireland. *Journal of Industrial Relations*, 46(3), 298-322.
- Williams, K. D. (2001). *Ostracism: The Power Of Silence*. New York: Guilford Press.
- Williams, K. D., Forgas, J. P., & Von Hippel, W. (Eds.). (2005). *The Social Outcast: Ostracism, Social Exclusion, Rejection, And Bullying*. Psychology Press.
- Withey, M. J., & Cooper, W. H. (1989). Predicting Exit, Voice, Loyalty, And Neglect. *Administrative Science Quarterly*, 521-539.

- Withey, M. J., & Cooper, W. H. (1989), "Predicting exit, voice, loyalty, and neglect," *Administrative Science Quarterly*, pp .521-539. 10.2307/2393565.
- Wu, C. H., Parker, S. K., Wu, L. Z., & Lee, C. (2018). When and why people engage in different forms of proactive behavior: Interactive effects of self-construals and work characteristics. *Academy of Management Journal*, 61(1), 293-323.
- Xanthopoulou, D., Bakker, A. B., Demerouti, E., & Schaufeli, W. B. (2009). Reciprocal relationships between job resources, personal resources, and work engagement. *Journal of Vocational Behavior*, 74(3), 235-244.
- Xie, J., Chu, X., Zhang, J. and Huang, J. (2014), " Proactive Personality and Voice Behavior: The Influence of Voice Self-Efficacy and Delegation," *Social Behavior and Personality: An International Journal*, Vol.42, pp.1191-1200. doi.org/10.2224/sbp.2014.42.7.1191.
- Xie, X. Y., Ling, C. D., Mo, S. J., & Luan, K. (2015). Linking colleague support to employees' promotive voice: A moderated mediation model. *Plos One*, 10(7), e0132123.
- Xiong Chen, Z., & Aryee, S. (2007). Delegation and employee work outcomes: An examination of the cultural context of mediating processes in China. *Academy of Management Journal*, 50(1), 226-238.
- Xue, Y., Li, X., Liang, H., & Li, Y. (2020). How does paradoxical leadership affect employees' voice behaviors in workplace? A leader-member exchange perspective. *International Journal of Environmental Research and Public Health*, 17(4), 1162.
- Yesil, S., & Sozbilir, F. (2013). An empirical investigation into the impact of personality on individual innovation behaviour in the workplace. *Procedia-Social and Behavioral Sciences*, 81, 540-551.
- Yildiz, M. A. (2016). Multiple mediation of emotion regulation strategies in the relationship between loneliness and positivity in adolescents. *Egitim ve Bilim*, 41(186).

- Yukl, G.(1998), *Leadership in Organizations* (4th ed), Prentice Hall, Englewood Cliffs, NJ.
- Yukl, G., & Fu, P. P. (1999).Determinants of Delegation And Consultation By Managers. *Journal of Organizational Behavior*, 20,219–232. [http://dx.doi.org/10.1002/\(SICI\)1099-1379\(199903\)20:2_219::AID-JOB9223.0.CO;2-8](http://dx.doi.org/10.1002/(SICI)1099-1379(199903)20:2_219::AID-JOB9223.0.CO;2-8).
- Yukl, G., Wall, S., & Lepsinger, R. (1990). Preliminary Report On Validation Of The Managerial Practices Survey. In K. E. Clark & M. B. Clark (Eds.), *Measures of Leaderships* (pp. 223–238). *West Orange, NJ: Leadership Library of America*.
- Yang,Yunyue. (2021). Understanding the Antecedents of Employee Voice: A Review of the Literature, 21(2), 58-86.
- Zhang, J., Song, L. J., Wang, Y., & Liu, G. (2018). How authentic leadership influences employee proactivity: the sequential mediating effects of psychological empowerment and core self-evaluations and the moderating role of employee political skill. *Frontiers of Business Research in China*, 12(1), 5.
- Zhang, J., Wu, Q., Miao, D., Yan, X., & Peng, J. (2014). The impact of core self-evaluations on job satisfaction: The mediator role of career commitment. *Social Indicators Research*, 116(3), 809-822.
- Zhang, X., & Bartol, K. M. (2010). Linking empowering leadership and employee creativity: The influence of psychological empowerment, intrinsic motivation, and creative process engagement. *Academy of Management Journal*, 53(1), 107-128. [/doi.org/10.5465/amj.2010.48037118](http://doi.org/10.5465/amj.2010.48037118).
- Zhang, X., Qian, J., Wang, B., Jin, Z., Wang, J., & Wang, Y. (2017). Leaders' behaviors matter: the role of delegation in promoting employees' feedback-seeking behavior. *Frontiers in Psychology*, 8, 920.
- Zhang, Y., Khan, U., Lee, S., & Salik, M. (2019). The influence of management innovation and technological innovation on organization performance. A mediating role of sustainability. *Sustainability*, 11(2), 495.
- Zhou, H., Feng, L., & Liu, A. (2017), "The Structure And Mechanism Of Voice Behavior: Based On The Perspective Of Motivation," *In Proceedings of the*

Tenth International Conference on Management Science and Engineering Management, pp. 467-47. Springer, Singapore. doi/10.1007/978-981-10-1837-4_40.

Zimmerman, B.J. (2001). Theories of self-regulated learning and academic achievement: An overview and analysis. In B.J. Zimmerman & D.H. Schunk (Eds.), *Self-regulated learning and academic achievement: Theoretical perspectives* (pp. 1-39). Mahwah, NJ: Erlbaum.

Appendix-A

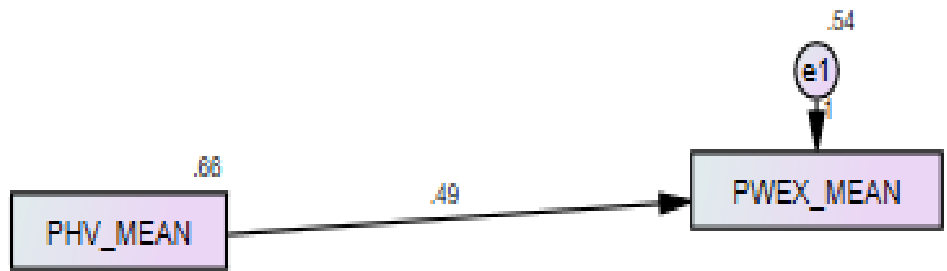
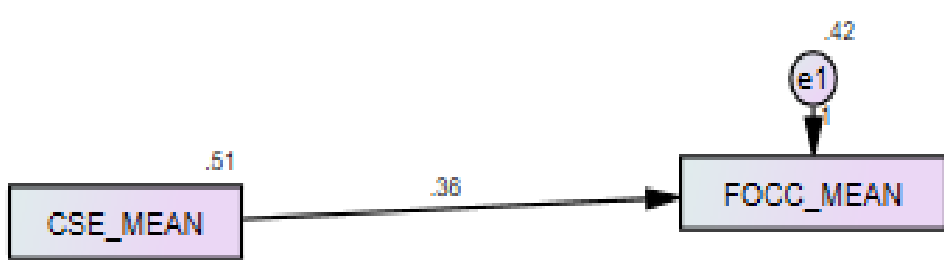

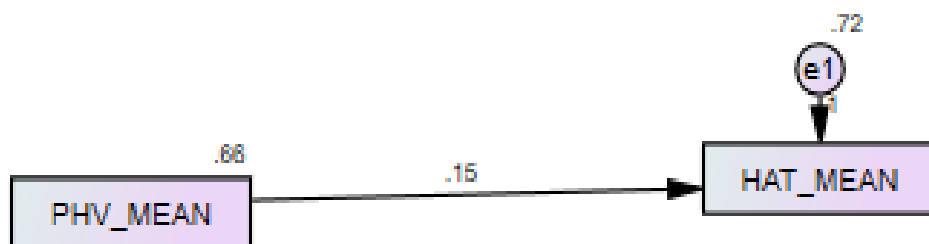
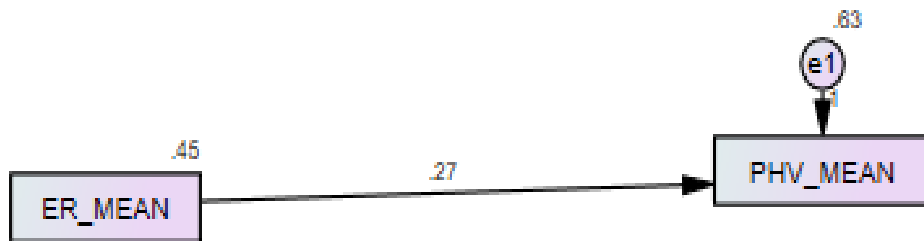
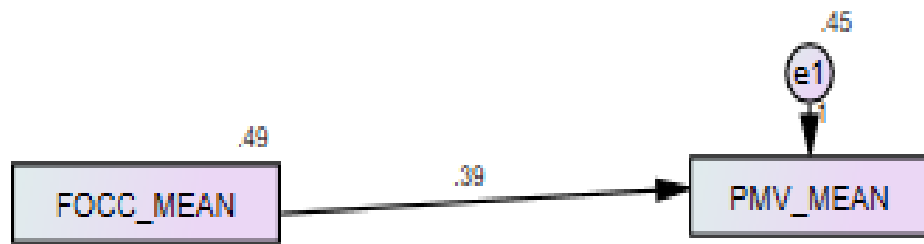
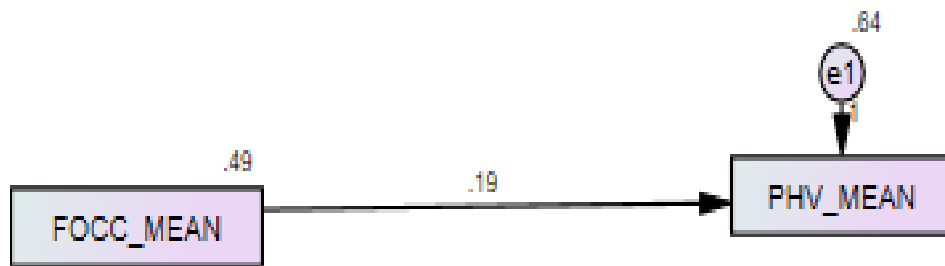

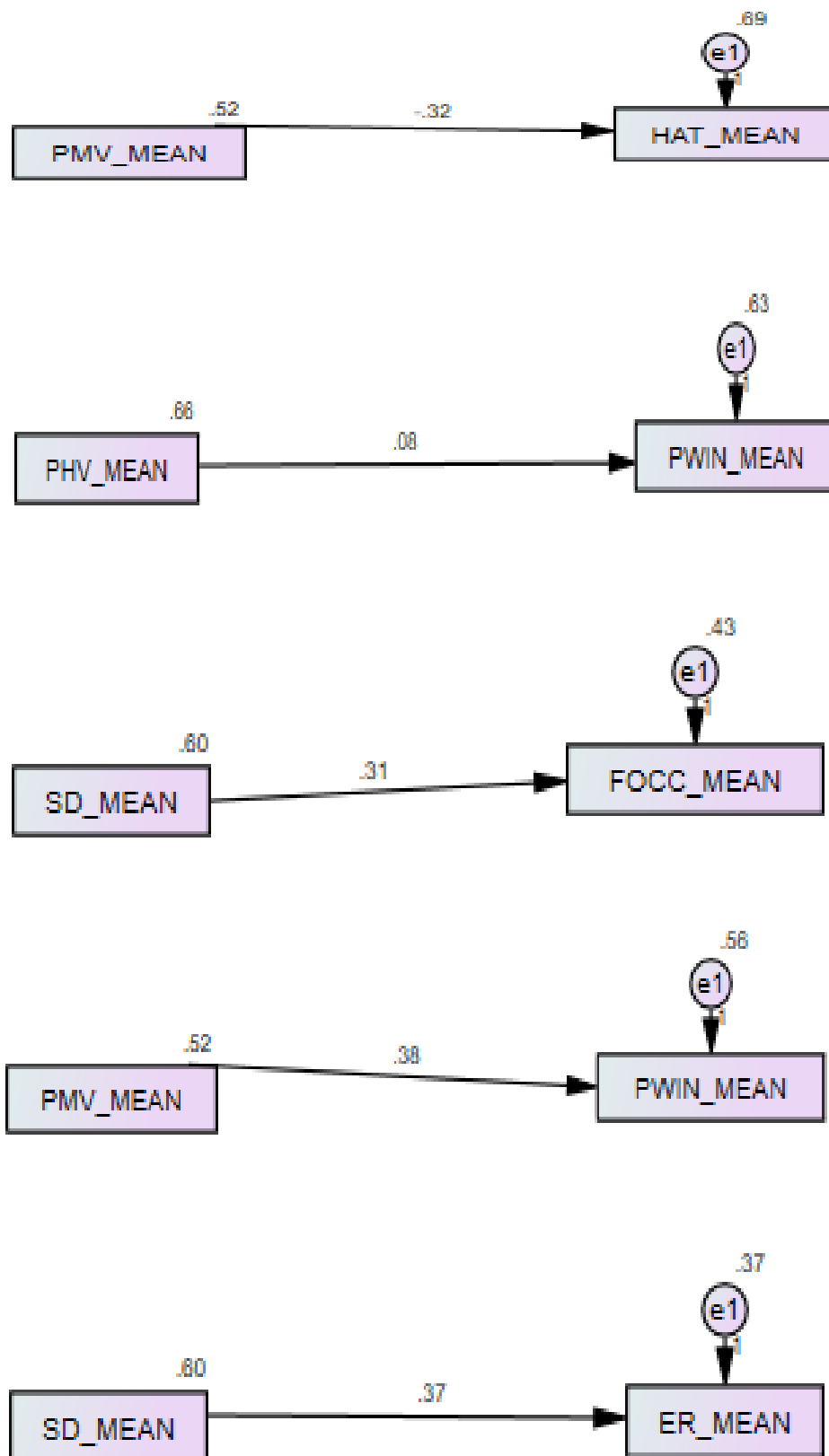

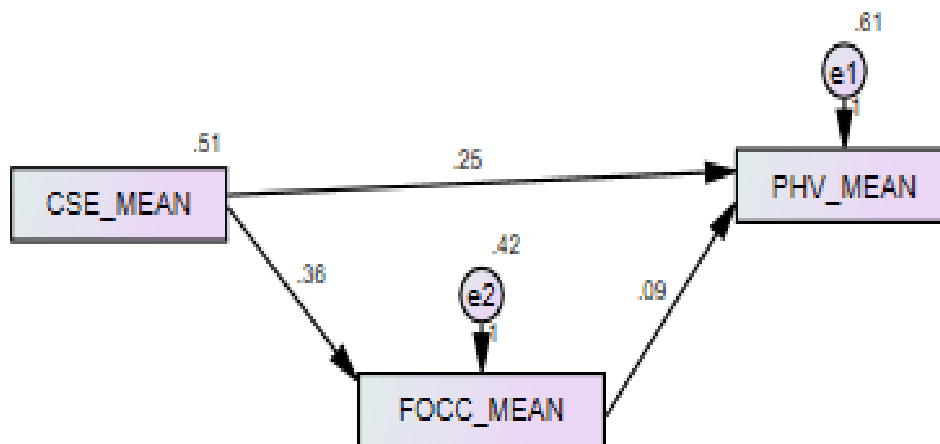
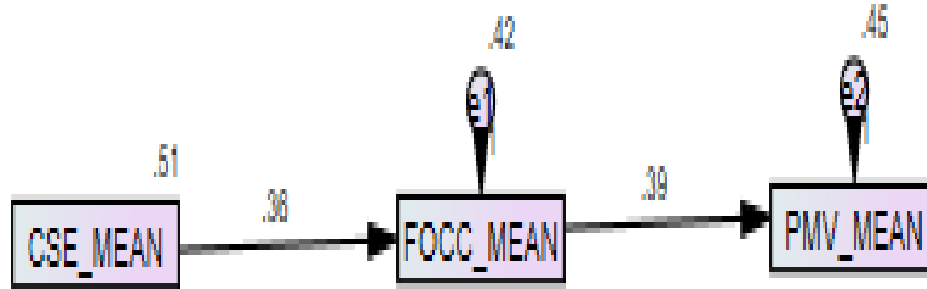
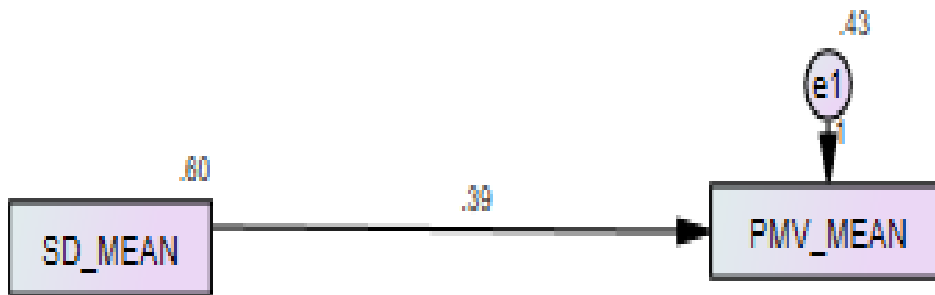
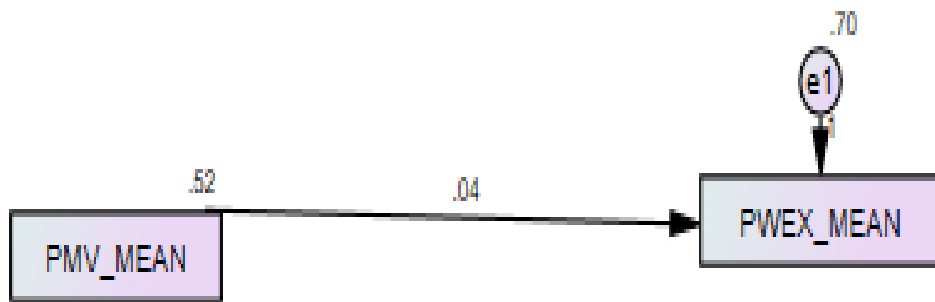

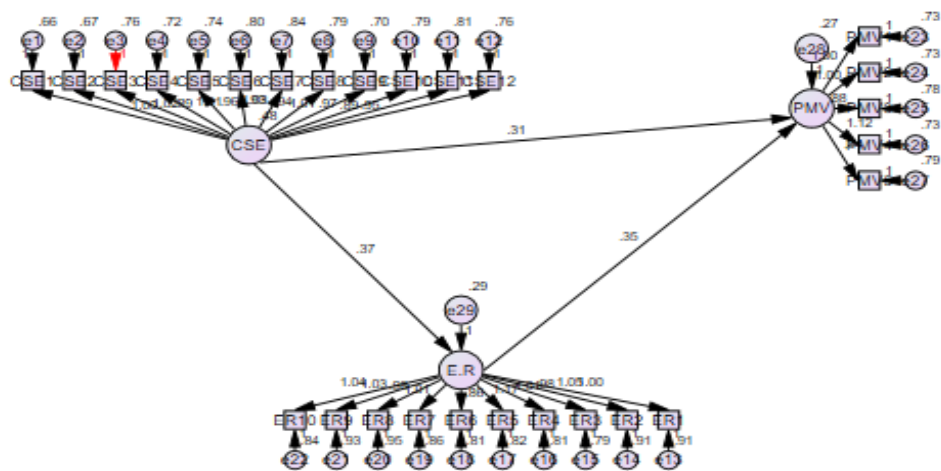
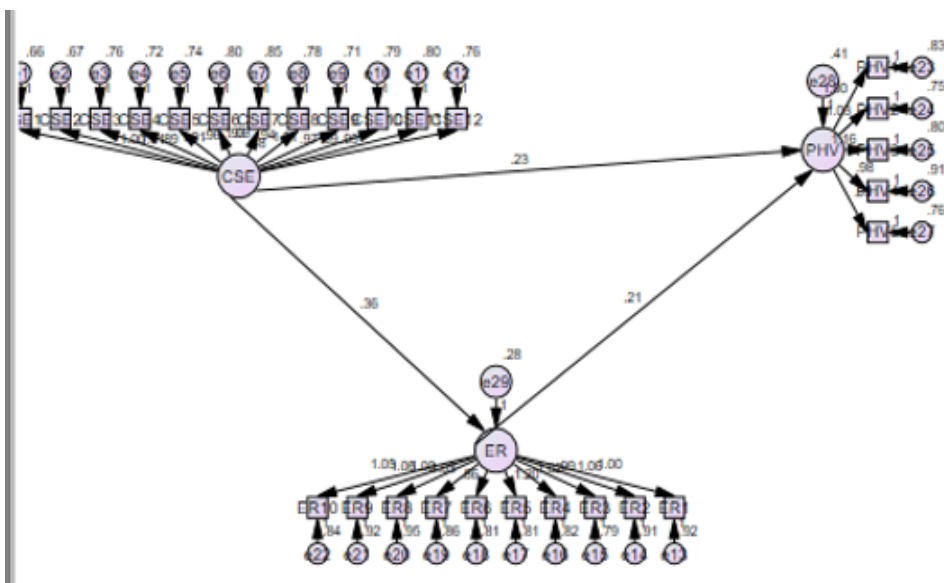
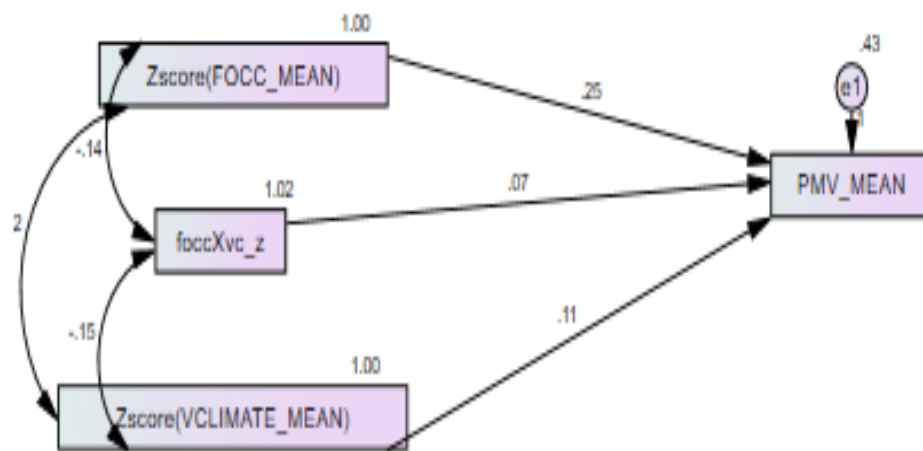

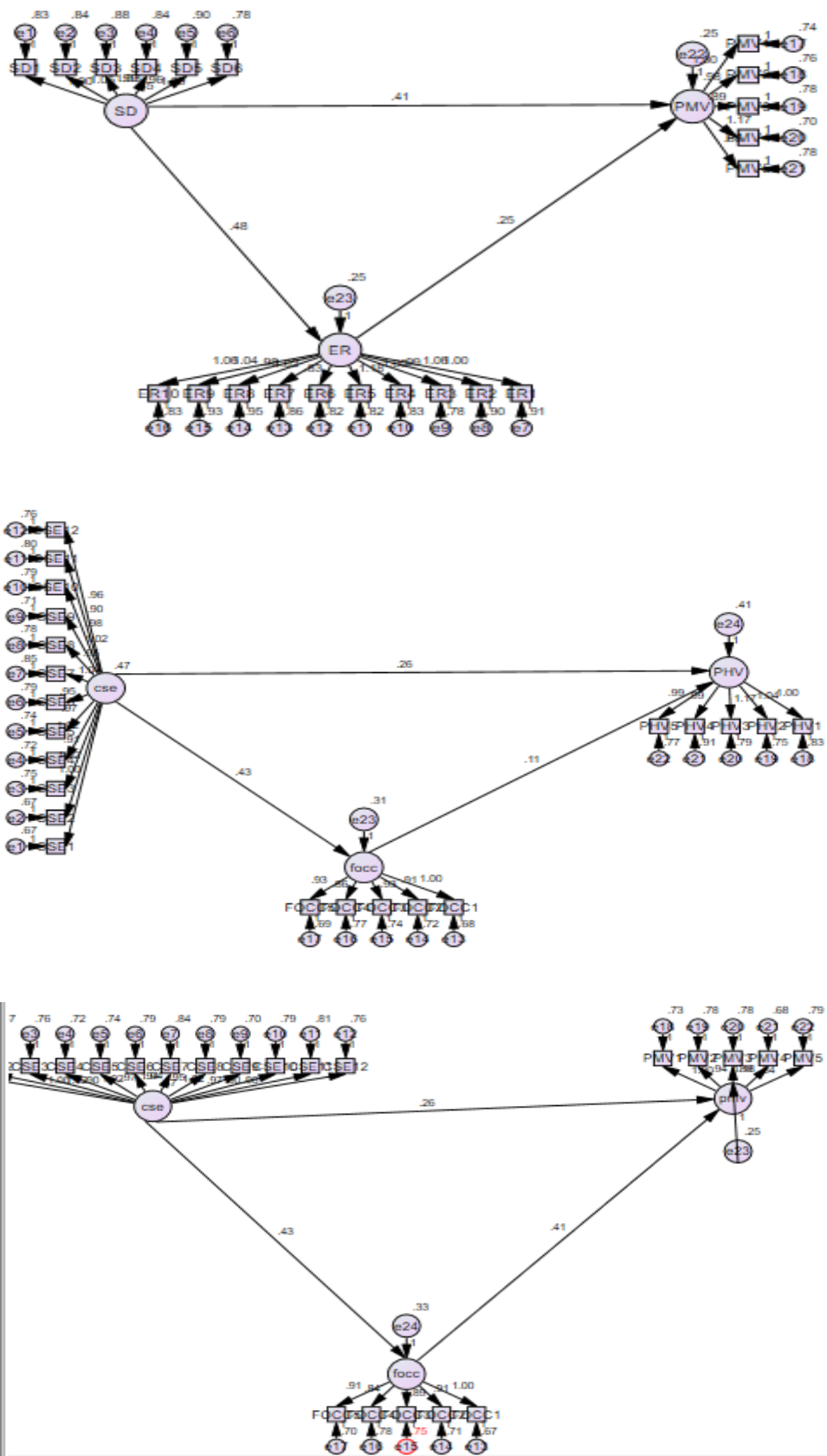

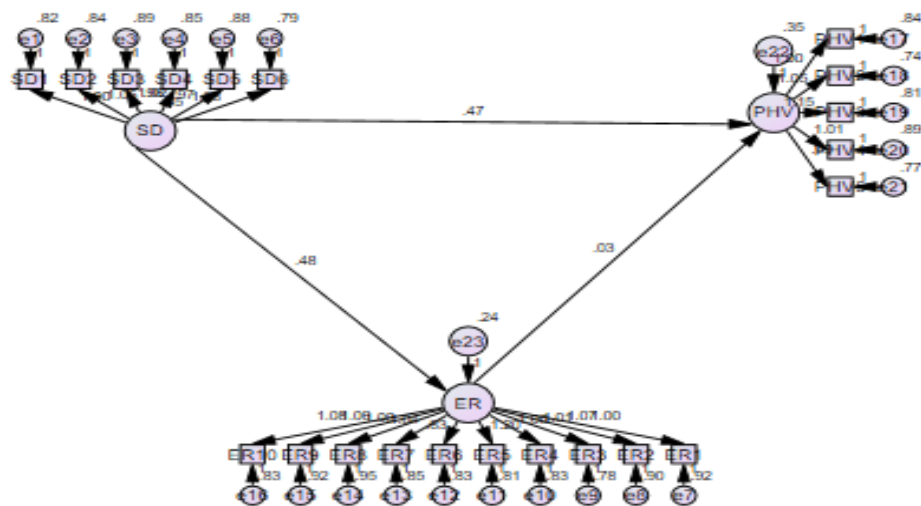
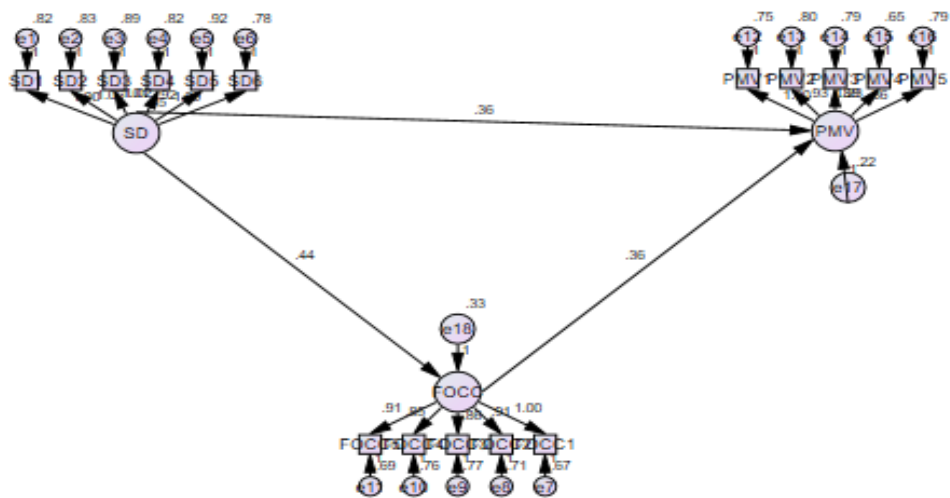
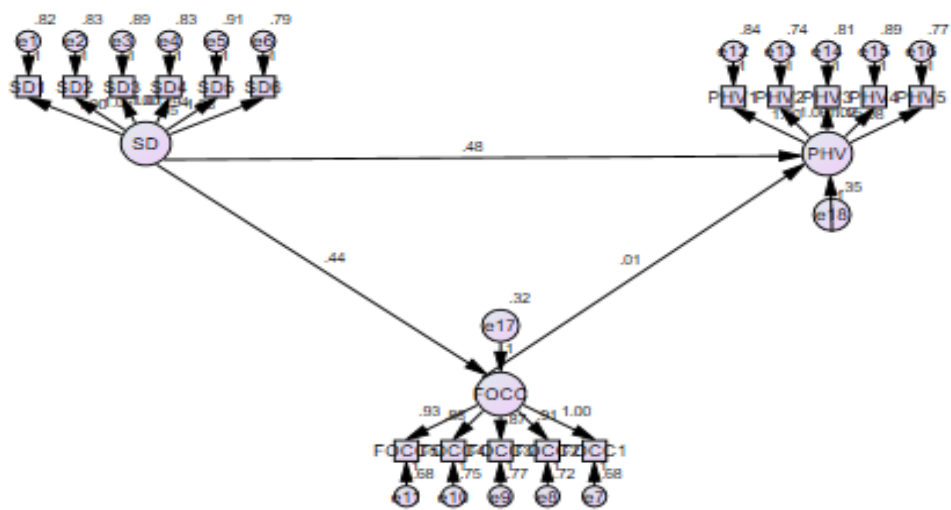

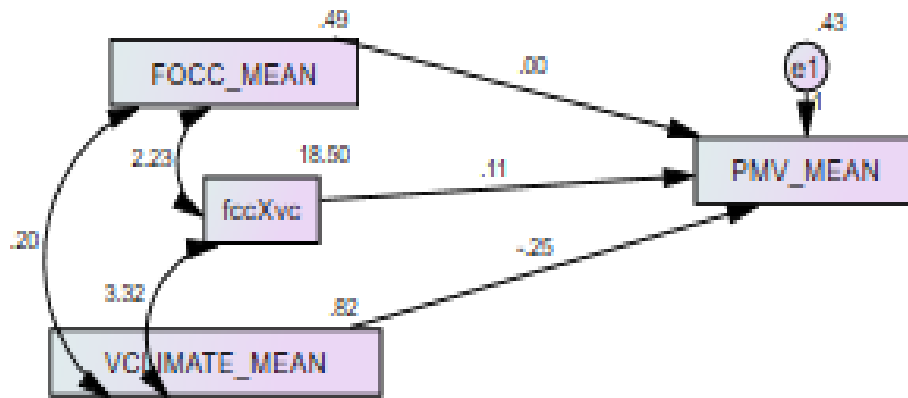

Validity

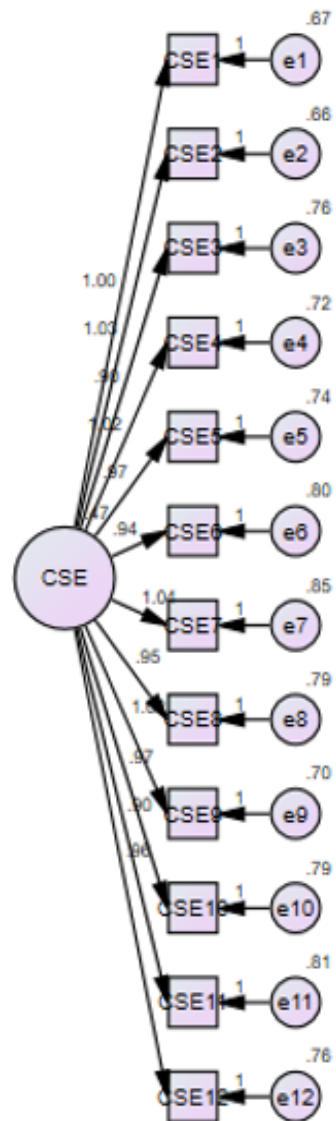

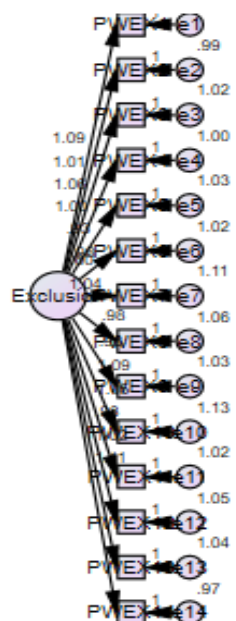
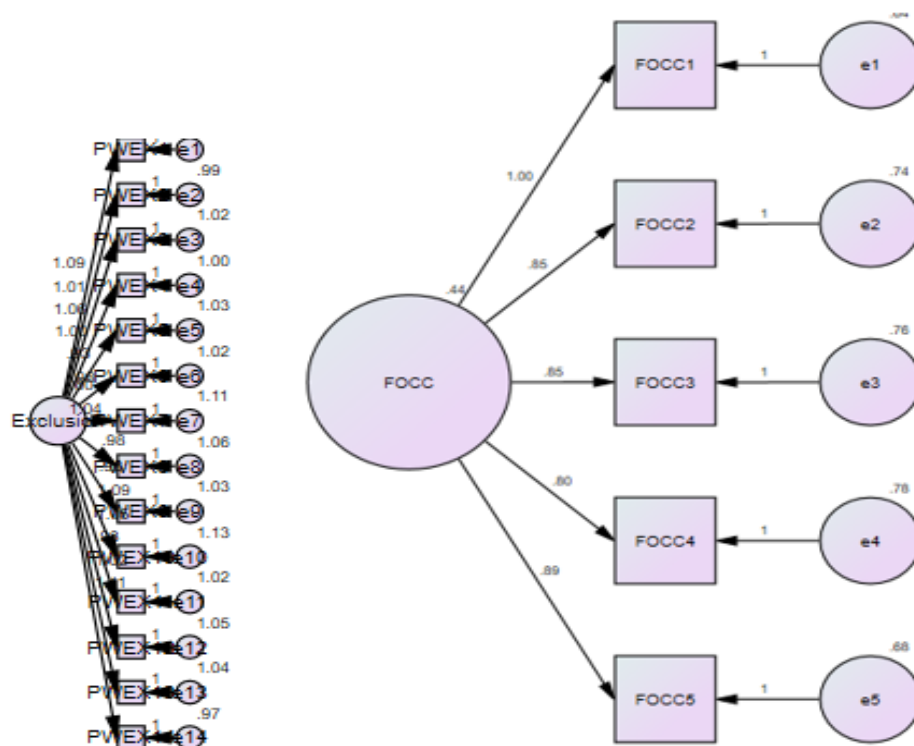
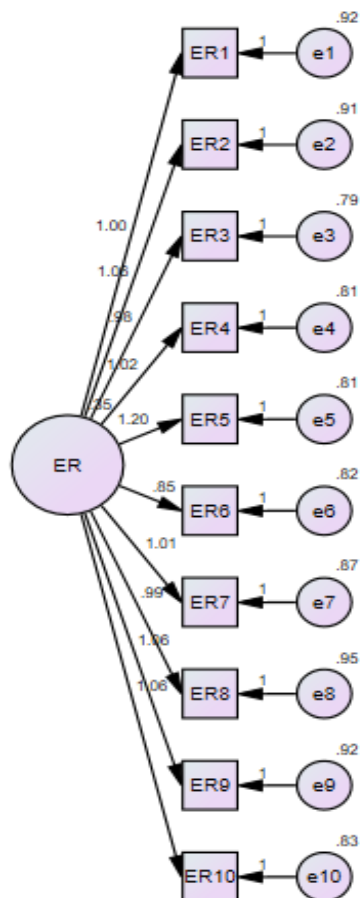

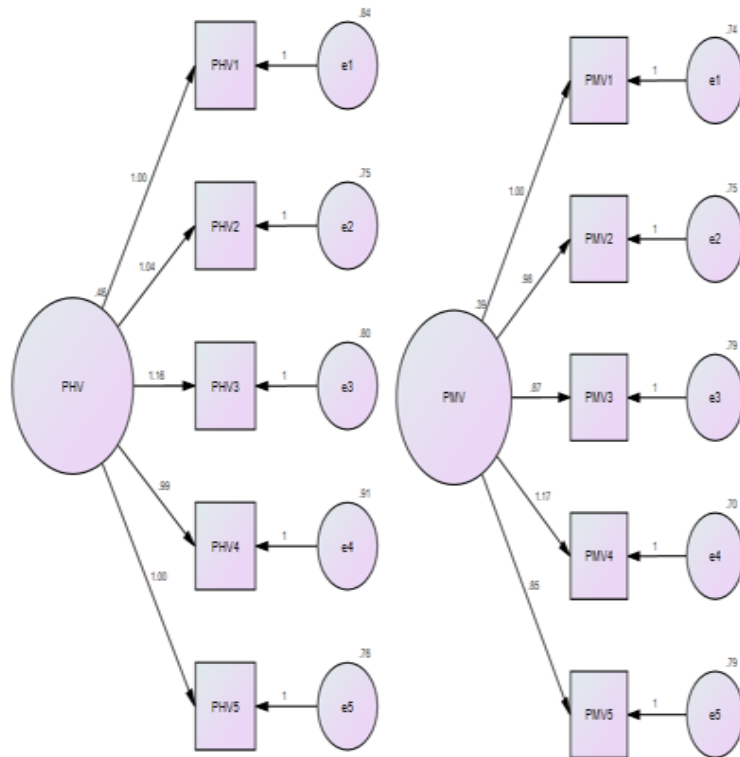
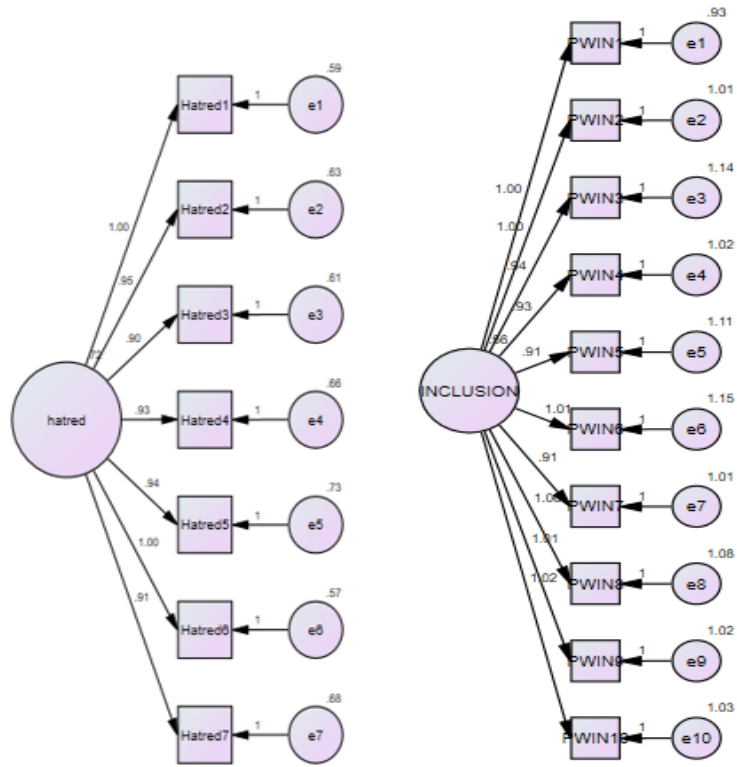

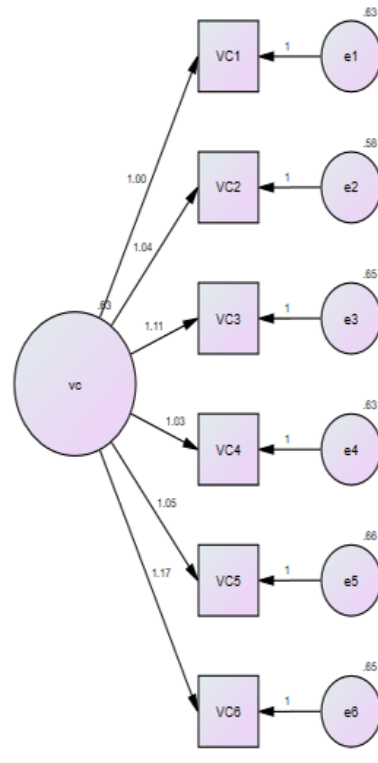
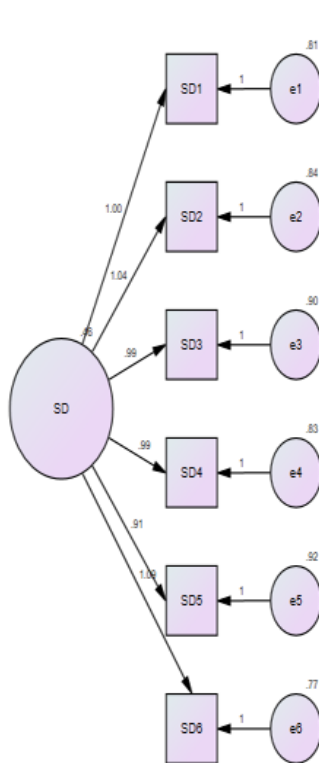
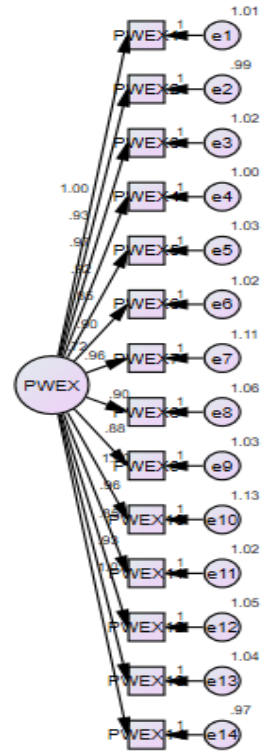
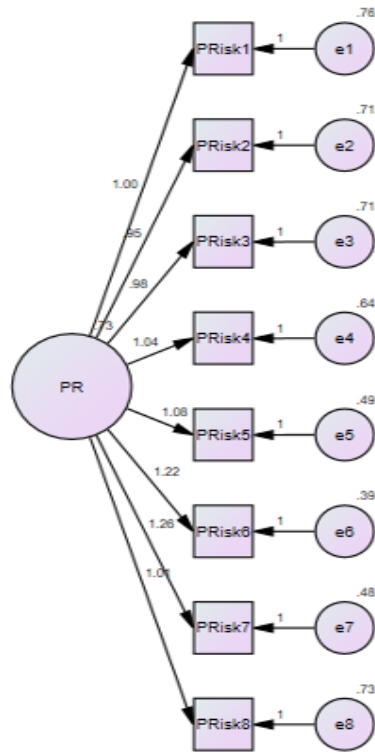

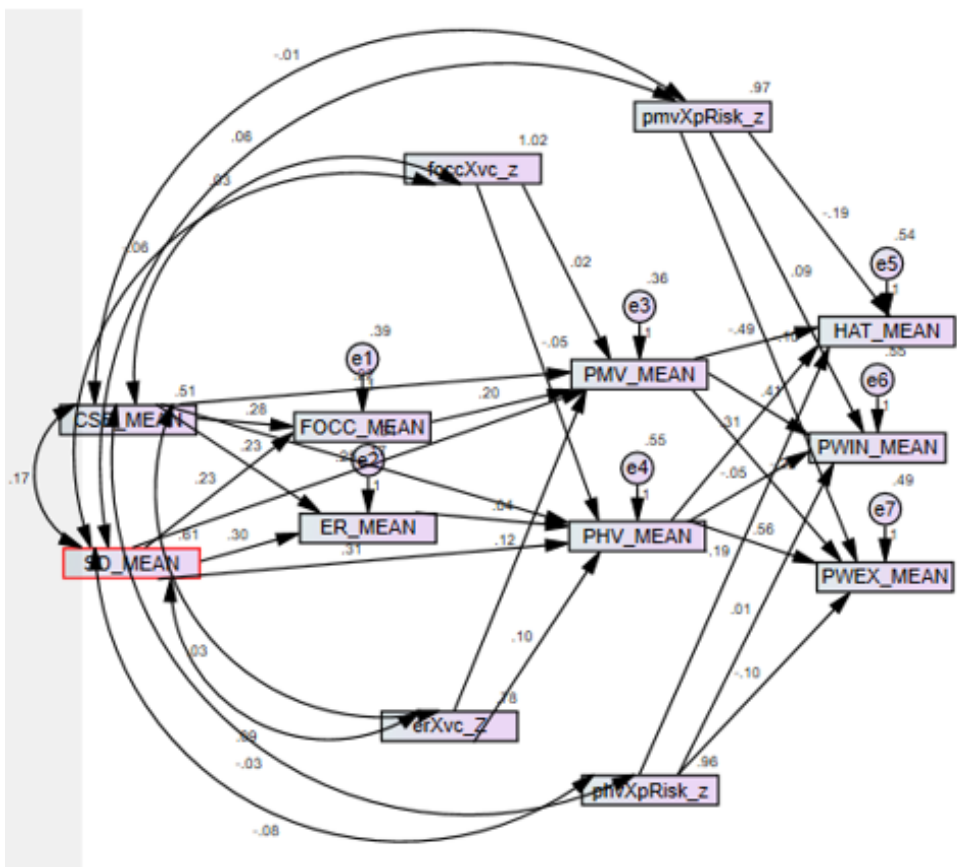
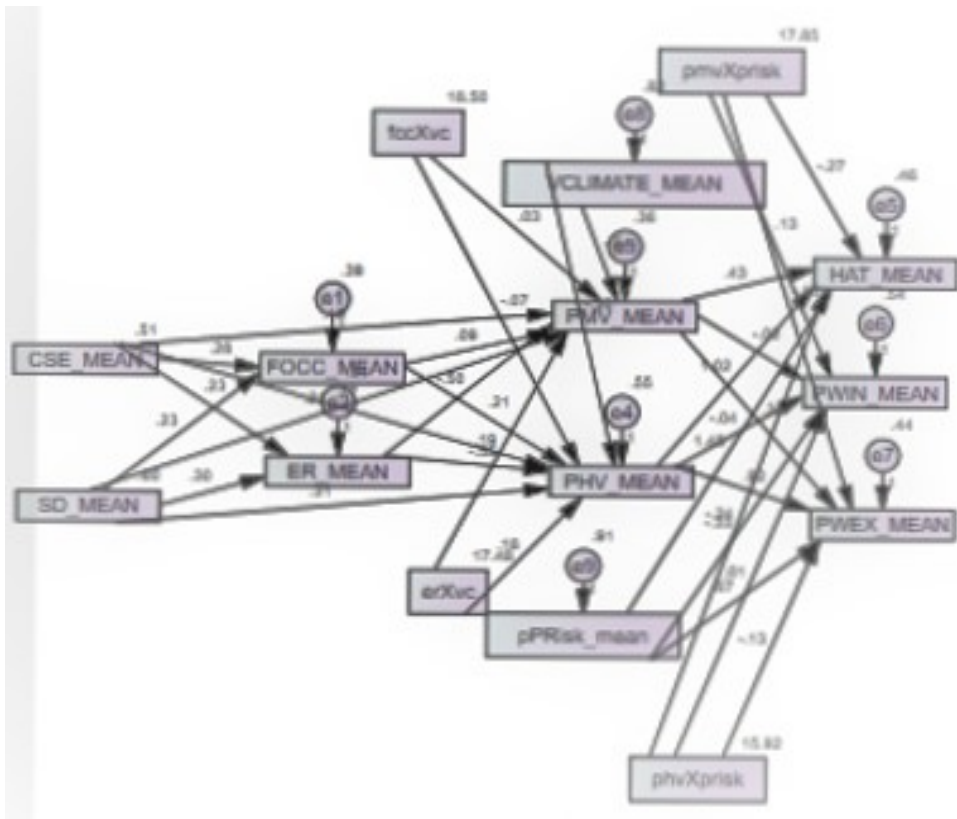

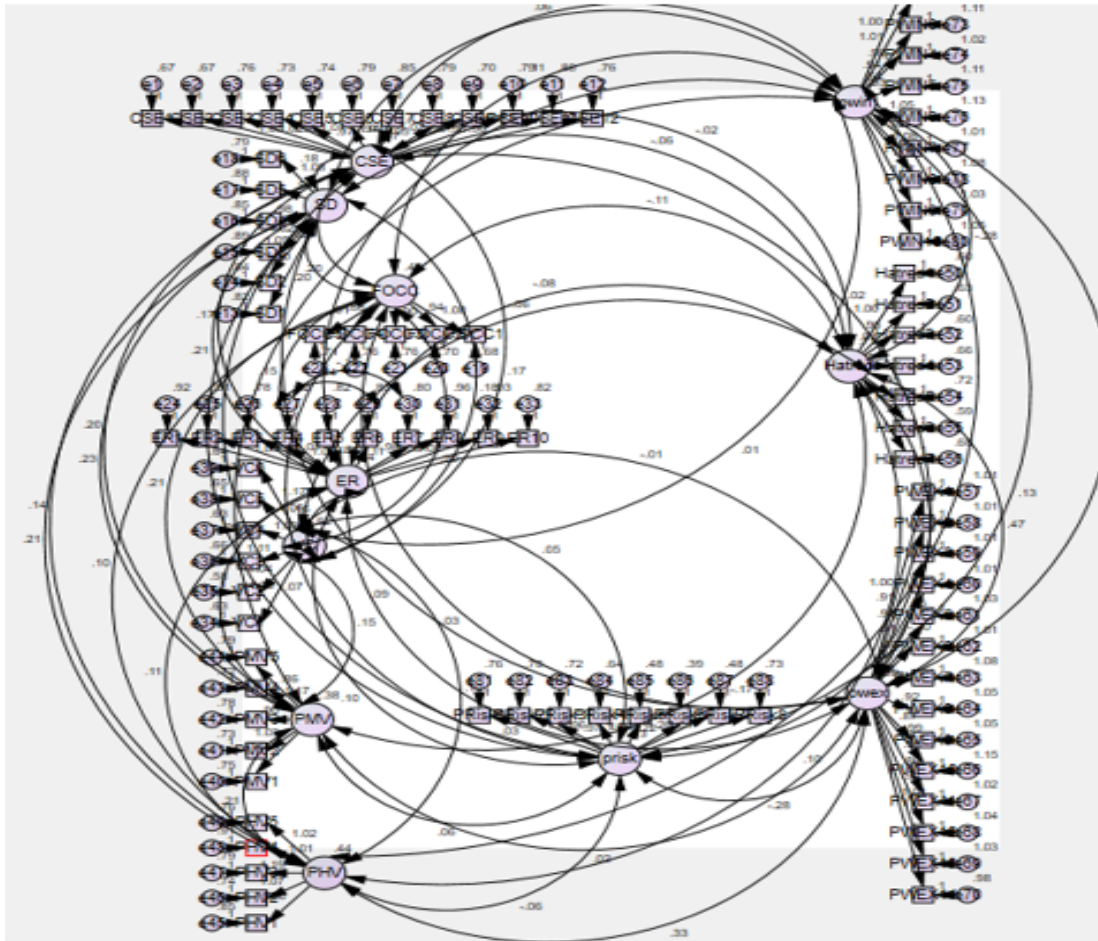

Appendix-B

Questionnaire

Time 1

Employee Identification Code:.....

Dear Respondent

I am PhD Scholar at Capital University of Science & Technology, wishing to conduct research on “voice behavior among employees” for the completion of my research thesis. In this regard, I have prepared following questionnaire, please note down that your identity as respondent is concealed so that you can freely express whatever the ground realities you see and face, any information obtained for this research will only be used for academic purpose. I really appreciate your time for filling up this questionnaire.

Regards,

Um-e-Rubbab,

PhD Scholar,

Faculty of Management and Social Sciences,

Capital University Science and Technology, Islamabad.

Section 1: Demographics

Your Gender	1- Male 2- Female
Your Martial Status	1- Single 2- Married
Your Age	1 (25-30), 2 (31-35), 3 (36-40), 4 (41-45), 5 (More than 50 years)
Qualification	1 (Bachelor) 2 (MS/M.Phil), 3 (Masters)
Tenure in this Organization:	1 (less than one year), 2 (1-3 years), 3 (4-7 years), 4 (7-10 years), 5 (more than 10 years)

Section 2: Core Self-Evaluation

Please tick the relevant choices: 1= strongly disagree, 2= disagree, 3 = neutral, 4= agree, 5= strongly agree.

1	I am confident I get the success I deserve in life.	1	2	3	4	5
2	Sometimes I feel depressed. (r)*	1	2	3	4	5
3	When I try, I generally succeed.	1	2	3	4	5
4	Sometimes when I fail I feel worthless. (r)*	1	2	3	4	5
5	I complete tasks successfully.	1	2	3	4	5
6	Sometimes, I do not feel in control of my work. (r)*	1	2	3	4	5
7	Overall, I am satisfied with myself	1	2	3	4	5
8	I am filled with doubts about my competence. (r)*.	1	2	3	4	5
9	I determine what will happen in my life	1	2	3	4	5
10	I do not feel in control of my success in my career. (r)*	1	2	3	4	5
11	I am capable of coping with most of my problems.	1	2	3	4	5
12	There are times when things look pretty bleak and hopeless to me. (r)*	1	2	3	4	5

Section 3: Supervisory Delegation

Please tick the relevant choices: 1= strongly disagree, 2= disagree, 3= neutral, 4= agree, 5= strongly agree.

1	My supervisor does not require that I get his/her input or approval before making decisions.	1	2	3	4	5
2	My supervisor lets me make decisions by myself, without consulting with him/her.	1	2	3	4	5
3	My supervisor gives me the authority to make my own decisions, without any input from him/her	1	2	3	4	5
4	I ask my supervisor for information and then make job-related decisions for myself	1	2	3	4	5
5	My supervisor gives me areas where I decide on my own, after first getting information from him/her	1	2	3	4	5
6	My supervisor permits me to get needed information from him/her and then make my own decisions.	1	2	3	4	5

Time 2

Employee Identification Code.....:

Section 4: FOCC

Please tick the relevant choices: 1= strongly disagree, 2= disagree, 3 = neutral, 4= agree, 5= strongly agree.

1	I owe it to the organization to do whatever I can to come up with ideas/solutions to achieve its goals	1	2	3	4	5
2	I have an obligation to the organization to voice out my own opinions.	1	2	3	4	5
3	I feel a personal obligation to produce constructive suggestions to help the organization achieve its goals	1	2	3	4	5
4	I owe it to the organization to do what I can to come up with brilliant ideas, to ensure that our customers are well served and satisfied	1	2	3	4	5
5	I would feel an obligation to take time from my personal schedule to generate ideas/solutions for the organization if it is needed.	1	2	3	4	5

Section 5: Emotion Regulation

Please tick the relevant choices: 1= strongly disagree, 2= disagree, 3 = neutral, 4= agree, 5= strongly agree.

1	When I want to feel more positive emotion (such as joy or amusement), I change what I'm thinking about	1	2	3	4	5
2	I keep my emotions to myself	1	2	3	4	5
3	When I want to feel less negative emotion (such as sadness or anger), I change what I'm thinking about	1	2	3	4	5

4	When I am feeling positive emotions, I am careful not to express them	1	2	3	4	5
5	When I'm faced with a stressful situation, I make myself think about it in a way that helps me stay calm	1	2	3	4	5
6	I control my emotions by not expressing them	1	2	3	4	5
7	When I want to feel more positive emotion, I change the way I'm thinking about the situation	1	2	3	4	5
8	I control my emotions by changing the way I think about the situation I'm in	1	2	3	4	5
9	When I am feeling negative emotions, I make sure not to express them	1	2	3	4	5
10	When I want to feel less negative emotion, I change the way I'm thinking about the situation	1	2	3	4	5

Section 6: Voice Climate

Please tick the relevant choices: 1= strongly disagree, 2= disagree, 3 = neutral, 4= agree, 5= strongly agree.

1	The employees in my work group are encouraged to develop and make recommendations concerning issues that affect the group	1	2	3	4	5
2	The employees in my work group are encouraged to speak up and get others involved in issues that affect the group	1	2	3	4	5
3	The employees in my work group are encouraged to communicate opinions about work issues with others in the group even if that opinion is different and others in the group disagree	1	2	3	4	5

4	The employees in my work group are encouraged to keep well informed about issues where our opinions might be useful to the group	1	2	3	4	5
5	The employees in my work group are encouraged to get involved in issues that affect the quality of work life here at work.	1	2	3	4	5
6	The employees in my work group are encouraged to speak up with new ideas or changes in procedures.	1	2	3	4	5

Time 3**Employee Identification Code:.....****Dear Respondent**

I am PhD Scholar at Capital University of Science & Technology, wishing to conduct research on “voice behavior among employees” for the completion of my research thesis. In this regard, I have prepared following questionnaire, please note down that your identity as respondent is concealed so that you can freely express whatever the ground realities you see and face, any information obtained for this research will only be used for academic purpose. I really appreciate your time for filling up this questionnaire.

Regard,

Um-e-Rubbab,

PhD Scholar,

Faculty of Management and Social Sciences,

Capital University Science and Technology, Islamabad.

Section 7: Voice Behavior

Please tick the relevant choices: 1-never, 2-not very often, 3-sometimes 4-very often, 5-constantly.

	Promotive voice					
1	Proactively develop and make suggestions for issues that may influence the unit	1	2	3	4	5
2	Proactively suggest new projects which are beneficial to the work unit	1	2	3	4	5
3	Raise suggestions to improve the unit’s working procedure.	1	2	3	4	5

4	Proactively voice out constructive suggestions that help the unit reach its goals.	1	2	3	4	5
5	Make constructive suggestions to improve the unit's operation	1	2	3	4	5
	Prohibitive voice					
6	Advise other colleagues against undesirable behaviors that would hamper job performance	1	2	3	4	5
7	Speak up honestly with problems that might cause serious loss to the work unit, even when/though dissenting opinions exist	1	2	3	4	5
8	Dare to voice out opinions on things that might affect efficiency in the work unit, even if that would embarrass others.	1	2	3	4	5
9	Dare to point out problems when they appear in the unit, even if that would hamper relationships with other colleagues	1	2	3	4	5
10	Proactively report coordination problems in the workplace to the management.	1	2	3	4	5

Section 8: Perceived Risk

Please tick the relevant choices: 1= strongly disagree, 2= disagree, 3 = neutral, 4= agree, 5= strongly agree.

While displaying voice behaviors at workplace, what will be the reaction of your supervisor.

1	He/she would think that I don't respect him/her"	1	2	3	4	5
2	I will offend him/her	1	2	3	4	5
3	Our relationship will deteriorate	1	2	3	4	5
4	He/she would think that I hurt his/her face	1	2	3	4	5

5	He/she would regard me as a trouble-maker”,	1	2	3	4	5
6	I will lose important job duties assigned by him/her	1	2	3	4	5
7	He/she would evaluate my performance as inconsistent with the firm goal	1	2	3	4	5
8	He/she will create troubles on my job in the future	1	2	3	4	5

Time 4

Employee Identification Code:.....

Section 9: Hatred

Please tick the relevant choices: 1= strongly disagree, 2= disagree, 3 = neutral, 4= agree, 5= strongly agree.

1	To what degree do you feel that the actions of the employee have offended you and/or members of your group over a long period of time?	1	2	3	4	5
2	To what degree do you estimate that some of the actions of employee are a result of a "bad" internal character	1	2	3	4	5
3	To what degree do you estimate that some of the actions of the employee are a result of an intentional desire to harm you and members of your group?	1	2	3	4	5
4	To what degree does the thought of the employee give rise to negative feelings in you?	1	2	3	4	5
5	To what degree do you estimate that the actions of the employee are just and legitimate?*	1	2	3	4	5
6	To what degree would you be glad to develop social relations with employee?*	1	2	3	4	5
7	To what degree would you be glad to know employee more closely?*	1	2	3	4	5

Section 10: Perceived Workplace Inclusion

Please tick the relevant choices: 1= strongly disagree, 2= disagree, 3 = neutral, 4= agree, 5= strongly agree.

1	Feel part of informal discussions in work group .	1	2	3	4	5
---	---	---	---	---	---	---

2	People in work group listen to what I say	1	2	3	4	5
3	My judgment is respected by members of work group	1	2	3	4	5
4	Work group members make me feel a part of decisions	1	2	3	4	5
5	Able to influence organizational decisions	1	2	3	4	5
6	Able to influence work assignment decisions	1	2	3	4	5
7	Consulted about important project decisions	1	2	3	4	5
8	Have a say in the way work is performed	1	2	3	4	5
9	Provided feedback by boss	1	2	3	4	5
10	Have all the materials I need to do my job	1	2	3	4	5

Section 11: Perceived Workplace Exclusion

Please tick the relevant choices: 1= strongly disagree, 2= disagree, 3 = neutral, 4= agree, 5= strongly agree.

1	Your boss or supervisor complimenting you on a job well done.*	1	2	3	4	5
2	Co-workers giving you the “silent treatment”	1	2	3	4	5
3	Co-workers shutting you out of their conversations.	1	2	3	4	5
4	Co-workers giving you the impression that they enjoy your company.*	1	2	3	4	5
5	Co-workers interacting with you only when they are required to do so.	1	2	3	4	5
6	Feeling accepted by other employees at your organization.*	1	2	3	4	5
7	Employees updating you about important work-related activities.*	1	2	3	4	5
8	Supervisors not replying to your requests/questions within a reasonable period of time	1	2	3	4	5

9	Co-workers making you feel like you were not a part of the organization	1	2	3	4	5
10	Supervisors inviting you to participate in work-related activities*	1	2	3	4	5
11	Supervisors keeping important work-related information from you (e.g., deadlines)	1	2	3	4	5
12	Supervisors interacting with you at work*	1	2	3	4	5
13	Felt as if you were being ostracized by co-workers	1	2	3	4	5
14	Felt as if you were being ostracized by supervisors	1	2	3	4	5